

TRANSMITTAL LETTER TO THE UNITED STATES
DESIGNATED/ELECTED OFFICE (DO/EO/US)
CONCERNING A FILING UNDER 35 U.S.C. 371

018428-000300US

U.S. APPLICATION NO. (If known, see 37 CFR 1.51)

09/402277

INTERNATIONAL APPLICATION NO.
PCT/GB98/00961

INTERNATIONAL FILING DATE
April 1, 1998

PRIORITY DATE CLAIMED
April 1, 1997

TITLE OF INVENTION
METHOD OF NUCLEIC ACID AMPLIFICATION

APPLICANT(S) FOR DO/EO/US
ERIC KAWASHIMA; LAURENT FARINELLI; PASCAL MAYER

Applicant herewith submits to the United States Designated/Elected Office (DO/EO/US) the following items and other information:

1. This is a **FIRST** submission of items concerning a filing under 35 U.S.C. 371.
2. This is a **SECOND** or **SUBSEQUENT** submission of items concerning a filing under 35 U.S.C. 371.
3. This express request to begin national examination procedures (35 U.S.C. 371(f)) at any time rather than delay examination until the expiration of the applicable time limit set in 35 U.S.C. 371(b) and PCT Articles 22 and 39(1).
4. A proper Demand for International Preliminary Examination was made by the 19th month from the earliest claimed priority date.
5. A copy of the International Application as filed (35 U.S.C. 371(c)(2))
 - a. is transmitted herewith (required only if not transmitted by the International Bureau).
 - b. has been transmitted by the International Bureau.
 - c. is not required, as the application was filed in the United States Receiving Office (RO/US).
6. A translation of the International Application into English (35 U.S.C. 371(c)(2)).
7. Amendments to the claims of the International Application under PCT Article 19 (35 U.S.C. 371(c)(3))
 - a. are transmitted herewith (required only if not transmitted by the International Bureau).
 - b. have been transmitted by the International Bureau.
 - c. have not been made; however, the time limit for making such amendments has NOT expired.
 - d. have not been made and will not be made.
8. A translation of the amendments to the claims under PCT Article 19 (35 U.S.C. 371(c)(3)).
9. An oath or declaration of the inventor(s) (35 U.S.C. 371(c)(4)).
10. A translation of the annexes to the International Preliminary Examination Report under PCT Article 36 (35 U.S.C. 371(c)(5)).

Items 11. to 16. below concern document(s) or information included:

11. An Information Disclosure Statement under 37 CFR 1.97 and 1.98.
12. An assignment document for recording. A separate cover sheet in compliance with 37 CFR 3.28 and 3.31 is included.
13. A **FIRST** preliminary amendment.
 A **SECOND** or **SUBSEQUENT** preliminary amendment.
14. A substitute specification.
15. A change of power of attorney and/or address letter.
16. Other items or information:
International Search Report
International Preliminary Examination Report w/amended claim sheets 70-77

66060 4422060

CALCULATIONS PTO USE ONLY

17. The following fees are submitted:
BASIC NATIONAL FEE (37 CFR 1.492 (a) (1) - (5)) :
 Neither international preliminary examination fee (37 CFR 1.482)
 nor international search fee (37 CFR 1.445(a)(2)) paid to USPTO
 and International Search Report not prepared by the EPO or JPO \$970.00
 International preliminary examination fee (37 CFR 1.482) not paid to
 USPTO but International Search Report prepared by the EPO or JPO..... \$840.00
 International preliminary examination fee (37 CFR 1.482) not paid to USPTO but
 international search fee (37 CFR 1.445(a)(2)) paid to USPTO \$760.00
 International preliminary examination fee paid to USPTO (37 CFR 1.482)
 but all claims did not satisfy provisions of PCT Article 33(1)-(4)..... \$670.00
 International preliminary examination fee paid to USPTO (37 CFR 1.482)
 and all claims satisfied provisions of PCT Article 33(1)-(4) \$96.00

ENTER APPROPRIATE BASIC FEE AMOUNT = \$ 840

Surcharge of \$130.00 for furnishing the oath or declaration later than 20 30
 months from the earliest claimed priority date (37 CFR 1.492(e)). \$

CLAIMS	NUMBER FILED	NUMBER EXTRA	RATE	
Total claims	37 - 20 =	+17	X \$18.00	\$ 306
Independent claims	3 - 3 =		X \$78.00	\$
MULTIPLE DEPENDENT CLAIM(S) (if applicable)			+ \$260.00	\$
TOTAL OF ABOVE CALCULATIONS =				\$ 1,146

Reduction of 1/2 for filing by small entity, if applicable. A Small Entity Statement
 must also be filed (Note 37 CFR 1.9, 1.27, 1.28). \$

SUBTOTAL = \$

Processing fee of \$130.00 for furnishing the English translation later than 20 30
 months from the earliest claimed priority date (37 CFR 1.492(f)). \$

TOTAL NATIONAL FEE = \$ 1,146

Fee for recording the enclosed assignment (37 CFR 1.21(h)). The assignment must be
 accompanied by an appropriate cover sheet (37 CFR 3.28, 3.31). \$40.00 per property + \$

TOTAL FEES ENCLOSED = \$ 1,146

Amount to be:	\$
refunded	
charged	\$

- a. A check in the amount of \$ _____ to cover the above fees is enclosed.
- b. Please charge my Deposit Account No. 20-1430 in the amount of \$ 1,146 to cover the above fees.
 A duplicate copy of this sheet is enclosed.
- c. The Commissioner is hereby authorized to charge any additional fees which may be required, or credit any
 overpayment to Deposit Account No. 20-1430. A duplicate copy of this sheet is enclosed.

NOTE: Where an appropriate time limit under 37 CFR 1.494 or 1.495 has not been met, a petition to revive (37 CFR 1.137(a) or (b)) must be filed and granted to restore the application to pending status.

SEND ALL CORRESPONDENCE TO:
 William M. Smith
 Townsend and Townsend and Crew LLP
 Two Embarcadero Center, 8th Fl.
 San Francisco, CA 94111

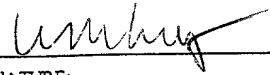
 SIGNATURE:
William M. Smith
 NAME
30,223
 REGISTRATION NUMBER

09/402274

PATENT

Attorney Docket No.: 18428-000300US

Client Reference No.: PS3253/USw/0

420 Rec'd PCT/PTO 30 SEP 1999

IN THE UNITED STATES PATENT AND TRADEMARK OFFICE

In re U.S. National Phase of
PCT/GB98/00961 of:

ERIC KAWASHIMA, et al.

Application No.: Not yet assigned

Filed: Herewith

For: METHOD OF NUCLEIC ACID
AMPLIFICATION

PRELIMINARY AMENDMENT

San Francisco, CA 94111
September 30, 1999

Box PCT
Assistant Commissioner for Patents
Washington, D.C. 20231

Sir:

Prior to examination of the above-referenced application, please enter the following amendments and remarks.

IN THE SPECIFICATION:

At line 1, please add the following sentence:

--This application claims priority to International Patent Application Number: PCT/GB98/00961 (published as WO 98/44151), which is incorporated by reference herein in its entirety.--

IN THE CLAIMS:

Note: the claims under amendment are claims 1-66 on amended sheets 70-77 attached hereto, which were submitted in applicant's letter of January 29, 1999.

09/402274

Claim 3, line 1, please delete "or claim 2".

Claim 4, line 1, delete "any preceding claim" and substitute therefor
--claim 1--.

Claim 5, line 1, delete "or claim 4".

Claim 6, line 1, delete "any of claims 3 to 5" and substitute therefor
--claim 3--.

Claim 7, line 1, delete "any preceding claim" and substitute therefor
--claim 1--.

Claim 8, line 1, delete "any of claims 1 to 6" and substitute therefor
--claim 1--.

Claim 11, line 1, delete "any of claims 8 to 10" and substitute therefor
--claim 8--.

Claim 12, line 1, delete "any preceding claim" and substitute therefor
--claim 1--.

Claim 13, line 1, delete "any preceding claim" and substitute therefor
--claim 1--.

Claim 14, line 1, delete "any preceding claim" and substitute therefor
--claim 1--.

Claim 15, line 1, delete "any preceding claim" and substitute therefor
--claim 1--.

Claim 16, line 1, delete "claim 15 when dependent upon".

Claim 18, line 1, delete "any preceding claim" and substitute therefor
--claim 1--.

Claim 19, line 1, delete "any preceding claim" and substitute therefor
--claim 1--.

Claim 21, line 1, delete "any preceding claim" and substitute therefor
--claim 1--.

Claim 22, line 1, delete "any preceding claim" and substitute therefor
--claim 1--.

660663" 660663

Claim 23, line 1, delete "any preceding claim" and substitute therefor
--claim 1--.

Claim 25, line 1, delete "or 24".

Claim 26, line 1 delete "any of claims 23 to 25" and substitute therefor
--claim 23--.

Please cancel claims 31-58

Claim 59, lines 1-2, delete "any of claims 1 to 26" and substitute therefor
--claim 1--.

Claim 61, line 2, delete "any of claims 27 to 30" and substitute therefor
--claim 27--.

Please amend claim 62 as follows:

62. (amended) An apparatus according to claim 61 wherein said detector means has sufficient resolution to distinguish between the distinct areas [referred to in claim 28] on a surface, each area comprising a plurality of identical nucleic acid strands and a plurality of identical complementary strands thereto; wherein each nucleic acid strand within such an area is located so that another nucleic acid strand is located on the surface within a distance of the length of that strand.

Claim 63, line 1, delete "or claim 62".

Claim 65, line 3, delete "any of claims 27 to 30" and substitute therefor
--claim 27--.

Please cancel claim 66.

REMARKS

Claims 1-30 and 59-65 are pending. Amendment is made to delete all multiple dependencies from the claims, thereby avoiding the need to pay the multiple dependent surcharge, and to cancel non-statutory claim 66, in addition to claims 31-58.

ERIC KAWASHIMA, et al.
Application No.: Not yet assigned
Page 4

PATENT

Respectfully submitted,

William M. Smith
Reg. No. 30,223

TOWNSEND and TOWNSEND and CREW LLP
Two Embarcadero Center, 8th Floor
San Francisco, California 94111-3834
Tel: (415) 576-0200
Fax: (415) 576-0300
WMS/tp
SF 1030862 v2

60663" 4660463

Claims

1. A method of nucleic acid amplification, comprising the steps of:
 - A. providing a plurality of primers that are immobilised but that have one end exposed to allow primer extension;
 - B. allowing a single stranded target nucleic acid molecule to anneal to one of said plurality of primers over part of the length of said single stranded nucleic acid molecule and then extending that primer using the annealed single stranded nucleic acid molecule as a template, so as to provide an extended immobilised nucleic acid strand;
 - C. separating the target nucleic molecule from the extended immobilised nucleic acid strand;
 - D. allowing the extended immobilised nucleic acid strand to anneal to one of said plurality of primers referred to in step A) and then extending that primer using the extended immobilised nucleic acid strand as a template, so as to provide another extended immobilised nucleic acid strand; and optionally,
 - E. separating the annealed extended immobilised nucleic acid strands from one another.

2. A method according to claim 1, further comprising:
 - F. using at least one extended immobilised nucleic acid strand to repeat steps D) and E), so as to provide additional extended immobilised nucleic acid strands and, optionally,
 - G. repeating step F) one or more times.

3. A method according to claim 1 or claim 2, wherein said single-stranded target nucleic acid is produced by providing a given nucleic acid sequence to be amplified (which sequence may be known or unknown) and adding thereto a first nucleic acid sequence and a second nucleic acid sequence; wherein said first nucleic acid sequence hybridises to one of said plurality of primers and said second nucleic acid sequence is complementary to a sequence which hybridises to one of said plurality of primers.

4. A method according to any preceding claim; wherein said single-stranded target nucleic acid is produced by providing a given nucleic acid sequence to be amplified (which sequence may be known or unknown) and adding thereto a first nucleic acid sequence and a second nucleic acid sequence; wherein said first nucleic acid sequence hybridises to one of said plurality of primers and said second nucleic acid sequence is the same as the sequence of one of said plurality of primers.

5. A method according to claim 3 or claim 4 wherein said first and second nucleic acid sequences are provided at first and second ends of said single-stranded target nucleic acid.

6. A method according to any of claims 3 to 5, wherein a tag is also added to the given nucleic acid sequence, said tag enabling amplification products of the given nucleic acid sequence to be identified.

7. A method according to any preceding claim wherein the plurality of primers is a plurality of primers that have the same sequence.

8. A method according to any of claims 1 to 6, wherein the plurality of primers comprises at least two different types of primer, one type having a different sequence from another type.

9. A method according to claim 8, wherein the plurality of primers consists of 2^n different types of primer; wherein n is an integer.

10. A method according to claim 9, where n is 2.

11. A method according to any of claims 8 to 10, wherein the different types of primer are present in substantially the same concentrations as one another

12. A method according to any preceding claim, wherein the primers are substantially homogeneously dispersed over a given area

13. A method according to any preceding claim, wherein the primers are located in a predetermined arrangement (e.g. in a grid pattern)

14. A method according to any preceding claim, wherein a supply of nucleotides and a nucleic acid polymerase are used to extend primers

15. A method according to any preceding claim, wherein heating is used to separate annealed nucleic acid strands

16. A method according to claim 15 when dependent upon claim 14, wherein the nucleic acid polymerase is not rendered inactive by the heating conditions used to separate annealed nucleic acid strands.

17. A method according to claim 16, wherein said nucleic acid polymerase is *taq* polymerase, is another polymerase that is derivable from a thermophilic organism; or is a thermostable derivative thereof.

18. A method according to any preceding claim, wherein said primer extension results in the incorporation of one or more detectable labels (e.g. fluorescent labels or radiolabels) into extended immobilised nucleic acid strands.

19. A method according to any preceding claim, further including the step of treating one or more extended immobilised nucleic acid strands so as to release a nucleic acid molecule or a part thereof.

20. A method according to claim 19, wherein said treating consists of cleavage with a restriction endonuclease or with a ribozyme.

21. A method according to any preceding claim, wherein one or more of said primers has a restriction endonuclease recognition site or a ribozyme recognition site or has part of such a site, which part becomes complete when primer extension occurs.

22. A method according to any preceding claim that is automated to allow repeated cycles of nucleic acid amplification.

23. A method according to any preceding claim, when used to amplify a plurality of different nucleic acid sequences

24. A method according to claim 23, when used to amplify a plurality of different nucleic acid sequences simultaneously.

25. A method according to claim 23 or 24, wherein said different nucleic acid sequences are each provided with a first and second nucleic acid sequence as described in any of claims 3 to 5, said first and second nucleic acid sequences being the same for the each of the different nucleic acid sequences.

26. A method according to any of claims 23 to 25, wherein said different nucleic acid sequences are each provided with a different tag so that the different sequences can be distinguished from one another.

27. A plurality of immobilised nucleic acids producable by a method according to any preceding claim.

28. A plurality of immobilised nucleic acids in the form of one or more distinct areas on a surface, each area comprising a plurality of identical nucleic acid strands and a plurality of identical complementary strands thereto; wherein each nucleic acid strand within such an area is located so that another nucleic acid strand is located on the surface within a distance of the length of that strand.

29. A plurality of immobilised nucleic acids according to claim 27 or claim 28, wherein there is at least one distinct area present per mm^2 of surface on which the nucleic acids are immobilised.

30. A plurality of immobilised nucleic acids according to claim 28, wherein the number of distinct areas/ mm^2 of surface on which the nucleic acids are immobilised is greater than 1, greater than 10^2 , greater than 10^3 or greater than 10^4 .

31. The use of a method according to any of claims 1 to 26 or of a

plurality of immobilised nucleic acid molecules according to any of claims 27 to 30 in providing nucleic acid molecules for sequencing.

32. The use according to claim 31, wherein sequencing is performed by extending primers hybridised to single stranded nucleic acid molecules and detecting the nucleotides used in primer extension.

33. The use according to claim 32, wherein sequencing is performed in a step-by-step manner, whereby after extending a primer by a single nucleotide, the nucleotide is detected before a further nucleotide is used in primer extension.

34. The use according to claim 32 or 33, wherein said primers hybridise to the same sequences as the primers used in the method of claim 1 to provide the immobilised nucleic acid molecules for sequencing.

35. The use according to claim 32 or 33, wherein said primers have the same sequences as the primers used in the method of claim 1 to provide the immobilised nucleic acid molecules for sequencing.

36. The use according to claim 31, wherein nicks are provided in double-stranded nucleic acid molecules, nick translation is performed and the nucleotides used in nick translation are detected.

37. The use according to claim 31, wherein an RNA polymerase is used to synthesise an RNA strand from a DNA molecule and the nucleotides used to produce said RNA strand are detected.

38. The use according to any of claims 32 to 37, wherein all or at least some of said nucleotides are labelled nucleotides.

39. The use according to claim 38, wherein said labelled nucleotides all have the same label.

40. The use according to claim 38 or claim 39, wherein said labelled nucleotides are fluorescence labelled

41. The use according to any of claims 38 to 40, wherein a mixture of labelled and non-labelled nucleotides are used.

42. The use according to claim 41, wherein the labelled nucleotides comprise less than 50 % of the nucleotides used.

43. The use according to claim 42, wherein the labelled nucleotides comprise less than 10 % of the nucleotides used.

44. The use according to any of claims 31 to 43, wherein the sequencing is parallel sequencing of nucleic acid molecules present in at least 2 different distinct areas.

45. The use according to any of claims 31 to 43, wherein the sequencing is parallel sequencing of nucleic acid molecules present in over 10 different distinct areas.

46. The use according to any of claims 31 to 43, wherein the sequencing is parallel sequencing of nucleic acid molecules present in over 100 different distinct areas.

47. The use according to any of claims 31 to 43, wherein the sequencing is parallel sequencing of nucleic acid molecules present in over 1000 different distinct areas.

48. The use according to any of claims 31 to 43, wherein the sequencing is parallel sequencing of nucleic acid molecules present in over 1000000 different distinct areas.

49. The use according to any of claims 31 to 43, wherein a plurality of different sequences are determined in parallel.

50. The use of a method according to any of claims 1 to 26 or of a plurality of immobilised nucleic acid molecules according to any of claims 27 to 30 in providing amplified nucleic acid molecules for diagnosis.

51. The use of a method according to any of claims 1 to 26 or of a plurality of immobilised nucleic acid molecules according to any of claims 27 to 30 in providing amplified nucleic acid molecules for screening.

52. The use of a method according to any of claims 1 to 26 or of a plurality of immobilised nucleic acid molecules according to any of claims 27 to 30 in providing amplified nucleic acid molecules to be used as a support for other components.

53. The use of a method according to any of claims 1 to 26 or of a plurality of immobilised nucleic acid molecules according to any of claims 27 to 30 in generating additional nucleic acid molecules in free (rather than immobilised) form.

54. The use of a method according to claim 53 in *in situ* RNA synthesis

55. The use of a method according to any of claims 1 to 26 or of a plurality of immobilised nucleic acid molecules according to any of claims 27 to 30 in monitoring gene expression

56. The use of a method according to any of claims 1 to 26 or of a plurality of immobilised nucleic acid molecules according to any of claims 27 to 30 in identifying nucleic acid molecules with gene products that are rarely expressed.

57. The use of a method according to any of claims 1 to 26 or of a plurality of immobilised nucleic acid molecules according to any of claims 27 to 30 in identifying heterozygous individuals

58. The use of a method according to any of claims 1 to 26 or of a plurality of immobilised nucleic acid molecules according to any of claims 27 to 30 in nucleic acid fingerprinting

59. An apparatus for performing a method as described in any of claims 1 to 26; comprising a plurality of immobilised primers, a

nucleic acid polymerase, a plurality of nucleotides and means for separating annealed nucleic acid strands.

60. An apparatus according to claim 59, wherein the means for separating annealed nucleic acid strands comprises a controlled heating means.

61. An apparatus for analysing a plurality of nucleic acid molecules according to any of claims 27 to 30, wherein said apparatus comprises a source of reactants and detector means for detecting one or more signals produced after said reactants have been applied to said nucleic acid molecules.

62. An apparatus according to claim 61 wherein said detector means has sufficient resolution to distinguish between the distinct areas referred to in claim 28.

63. An apparatus according to claim 61 or claim 62 comprising a charge coupled device (CCD).

64. An apparatus according to claim 63 wherein said charge coupled device (CCD) is operatively connected with a magnifying device (e.g. a microscope).

65. A kit for use in screening, diagnosis or in nucleic acid sequencing; comprising a plurality of immobilised nucleic acid according to any of claims 27 to 30.

66. The invention substantially as hereinbefore described.

27/PRTS

Method of Nucleic Acid Amplification

This invention relates, *inter alia*, to the amplification of nucleic acids.

Molecular biology and pharmaceutical drug development now make intensive use of nucleic acid analysis (Friedrich, G.A. Moving beyond the genome projects, *Nature Biotechnology* 14, 1234 (1996)). The most challenging areas are whole genome sequencing, single nucleotide polymorphism detection, screening and gene expression monitoring. Currently, up to hundreds of thousands of samples are handled in single DNA sequencing projects (Venter, J.C., H.O Smith, L. Hood, A new strategy for genome sequencing, *Nature* 381, 364 (1996)). This capacity is limited by the available technology. Projects like the "human genome project" (gene mapping and DNA sequencing) and identifying all polymorphisms in expressed genes involved in common diseases imply the sequencing of millions of DNA samples.

With most of the current DNA sequencing technologies, it is simply not possible to decrease indefinitely the time required to process a single sample. A way of increasing throughput is to perform many processes in parallel. The introduction of robotic sample preparation and delivery, 96 and 384 well plates, high density gridding machines (Maier, E., S. Meierewer, A.R. Ahmadi, J. Curtis, H. Lehrach, Application of robotic technology to automated sequence fingerprint analysis by oligonucleotide hybridization, *Journal Of Biotechnology* 35,191 (1994)) and recently the development of high density oligonucleotide arrays (Chee, M., R.Yang, E. Hubbell, A. Berno, X.C. Huang, D. Stern, J. Winkler, D.J. Lockhart, M.S. Morris, and S.P.A. Fodor, Accessing genetic information with high-density DNA arrays, *Science* 274(5287):610-614, (1996)) are starting to bring answers to the demand in ever higher throughput. Such technologies allow up to 50,000~100,000 samples at a time to be processed within days and even hours (Maier, E., Robotic technology in library screening, *Laboratory Robotics and Automation* 7, 123 (1995)).

66666 44444

In most known methods for performing nucleic acid analysis, it is necessary to first extract the nucleic acids of interest (e.g., genomic or mitochondrial DNA or messenger RNA (mRNA)) from an organism. Then it is necessary to isolate the nucleic acids of interest from the mixture of all nucleic acids and usually, to amplify these nucleic acids to obtain quantities suitable for their characterisation and/or detection. Isolating the nucleic fragments has been considered necessary even when one is interested in a representative but random set of all of the different nucleic acids, for instance, a representative set of all the mRNAs present in a cell or of all the fragments obtained after genomic DNA has been cut randomly into small pieces.

Several methods can be used to amplify DNA with biological means and are well known by those skilled in the art. Generally, the fragments of DNA are first inserted into vectors with the use of restriction enzymes and DNA ligases. A vector containing a fragment of interest can then be introduced into a biological host and amplified by means of well established protocols. Usually hosts are randomly spread over a growth medium (e.g. agar plates). They can then replicate to provide colonies that originated from individual host cells.

Up to millions of simultaneous amplification of cloned DNA fragments can be carried out simultaneously in such hosts. The density of colonies is of the order of 1 colony/mm². In order to obtain DNA from such colonies one option is to transfer the colonies to a membrane, and then to immobilise the DNA from within the biological hosts directly to the membrane (Grunstein, M. and D.S. Hogness, Colony Hybridization: A method for the isolation of cloned DNAs that contain a specific gene, *Proceedings of the National Academy of Science, USA*, 72:3961 (1975)). With these options however, the amount of transferred DNA is limited and often insufficient for non-radioactive detection.

Another option is to transfer by sterile technique individually each colony into a container (e.g., 96 well plates) where further host cell replication can occur so that more DNA can be obtained from the colonies. Amplified nucleic acids can be recovered from the host

cells with an appropriate purification process. However such a procedure is generally time and labour consuming, and difficult to automate.

The revolutionary technique of DNA amplification using the polymerase chain reaction (PCR) was proposed in 1985 by Mullis et al. (Saiki, R., S. Scharf, F. Faloona, K. Mullis, G. Horn, H. Erlich and N. Arnheim, *Science* 230, 1350-1354 (1985) and is now well known by those skilled in the art. In this amplification process, a DNA fragment of interest can be amplified using two short (typically about 20 base long) oligonucleotides that flank a region to be amplified, and that are usually referred to as "primers". Amplification occurs during the PCR cycling, which includes a step during which double stranded DNA molecules are denatured (typically a reaction mix is heated, e.g. to 95°C in order to separate double stranded DNA molecules into two single stranded fragments), an annealing step (where the reaction mix is brought to e.g., 45°C in order to allow the primers to anneal to the single stranded templates) and an elongation step (DNA complementary to the single stranded fragment is synthesised via sequential nucleotide incorporation at the ends of the primers with the DNA polymerase enzyme).

The above procedure is usually performed in solution, whereby neither the primers nor a template are linked to any solid matrix.

More recently, however, it has been proposed to use one primer grafted to a surface in conjunction with free primers in solution in order to simultaneously amplify and graft a PCR product onto the surface (Oroskar, A.A., S.E. Rasmussen, H.N. Rasmussen, S.R. Rasmussen, B.M. Sullivan, and A. Johansson, Detection of immobilised amplicons by ELISA-like techniques, *Clinical Chemistry* 42:1547 (1996)). (The term "graft" is used herein to indicate that a moiety becomes attached to a surface and remains there unless and until it is desired to remove it.) The amplification is generally performed in containers (e.g., in 96 well format plates) in such a way that each container contains the PCR product(s) of one reaction. With such

methods, some of the PCR product become grafted to a surface of the container having primers therein which has been in contact with the reactant during the PCR cycling. The grafting to the surface simplifies subsequent assays and allows efficient automation.

Arraying of DNA samples is more classically performed on membranes (e.g., nylon or nitro-cellulose membranes). With the use of suitable robotics (e.g., Q-botSM, Genetix ltd, Dorset BH23 3TG UK) it is possible to reach a density of up to 10 samples/mm². Here, the DNA is covalently linked to a membrane by physicochemical means (e.g., UV irradiation). These technologies allow the arraying of large DNA molecules (e.g. molecules over 100 nucleotides long) as well as smaller DNA molecules. Thus both templates and probes can be arrayed.

New approaches based on pre-arrayed glass slides (arrays of reactive areas obtained by ink-jet technology (Blanchard, A.P. and L. Hood, *Oligonucleotide array synthesis using ink jets, Microbial and Comparative Genomics*, 1:225 (1996)) or arrays of reactive polyacrylamide gels (Yershov, G. et al., DNA analysis and diagnostics on oligonucleotide microchips, *Proceedings of the National Academy of Science, USA*, 93:4913-4918 (1996)) allow the arraying of up to 100 samples/mm². With these technologies, only probe (oligonucleotide) grafting has been reported. Reported number of samples/mm² are still fairly low (25 to 64).

Higher sample densities are achievable by the use of DNA chips, which can be arrays of oligonucleotides covalently bound to a surface and can be obtained with the use of micro-lithographic techniques (Fodor, S.P.A. et al., Light directed, spatially addressable parallel chemical synthesis, *Science* 251:767(1991)). Currently, chips with 625 probes/mm² are used in applications for molecular biology (Lockhart, D.J. et al., Expression monitoring by hybridisation to high-density oligonucleotide arrays, *Nature Biotechnology* 14:1675 (1996)). Probe densities of up to 250 000 samples/cm² are claimed to be achievable (Chee, M. et al., Accessing genetic information with

high-density DNA arrays, *Science* 274:610 (1996)). Currently, up to 132000 different oligonucleotides can be arrayed on a single chips of approximately 2.5 cm². Presently, these chips are manufactured by direct solid phase oligonucleotide synthesis with the 3'OH end of the oligo attached to the surface. Thus these chips have been used to provide oligonucleotide probes which cannot act as primers in a DNA polymerase-mediated elongation step.

When PCR products are linked to the vessel in which PCR amplification takes place, this can be considered as a direct arraying process. The density of the resultant array of PCR products is then limited by the available vessel. Currently available vessels are only in 96 well microtiter plate format. These allow only around ~0.02 samples of PCR products/mm² of surface to be obtained.

Using the commercially available Nucleolink™ system obtainable from Nunc A/S (Roskilde, Denmark) it is possible to achieve simultaneous amplification and arraying of samples in containers on the surface of which oligonucleotide primers have been grafted. However, in this case the density of the array of samples is fixed by the size of the vessel. Presently a density of 0.02 samples/mm² is achievable for the 96 well plate format. Increasing this density is difficult. This is apparent since, for instance, the availability of 384 well plates (0.08 samples/mm²) suitable for PCR has been delayed due to technical problems (e.g. heat transfer and capillary effects during filling). It is thus unlikely that orders of magnitude improvements in the density of samples arrayed with this approach can be achieved in the foreseeable future.

The present invention aims to overcome or at least alleviate some of the disadvantages of prior art methods of nucleic acid amplification.

According to the present invention there is provided a method of nucleic acid amplification, comprising the steps of:

- A. providing a plurality of primers that are immobilised but that have one end exposed to allow primer extension;
- B. allowing a single stranded target nucleic acid molecule to anneal to one of said plurality of primers over part of the length of said single stranded nucleic acid molecule and then extending that primer using the annealed single stranded nucleic acid molecule as a template, so as to provide an extended immobilised nucleic acid strand;
- C. separating the target nucleic molecule from the extended immobilised nucleic acid strand;
- D. allowing the extended immobilised nucleic acid strand to anneal to one of said plurality of primers referred to in step A) and then extending that primer using the extended immobilised nucleic acid strand as a template, so as to provide another extended immobilised nucleic acid strand; and optionally,
- E. separating the annealed extended immobilised nucleic acid strands from one another.

Preferably the method also comprises the step of:

- F. using at least one extended immobilised nucleic acid strand to repeat steps D) and E), so as to provide additional extended immobilised nucleic acid strands and, optionally,
- G. repeating step F) one or more times.

Desirably the single-stranded target nucleic acid sequence is provided by a method in which said single-stranded target nucleic acid is produced by providing a given nucleic acid sequence to be amplified (which sequence may be known or unknown) and adding thereto a first nucleic acid sequence and a second nucleic acid sequence; wherein said first nucleic acid sequence hybridises to one of said plurality of primers and said second nucleic acid sequence is complementary to a sequence which hybridises to one of said plurality of primers.

The second nucleic acid sequence may be a sequence that is the same as the sequence of one of the plurality of primers. Thus the single-stranded target nucleic acid sequence may be provided by a method in which said single-stranded target nucleic acid is produced by providing a given nucleic acid sequence to be amplified (which

sequence may be known or unknown) and adding thereto a first nucleic acid sequence and a second nucleic acid sequence; wherein said first nucleic acid sequence hybridises to one of said plurality of primers and said second nucleic acid sequence is the same as the sequence of one of said plurality of primers.

The first and second nucleic acid sequences may be provided at first and second ends of said single-stranded target nucleic acid, although this is not essential.

If desired a tag may be provided to enable amplification products of a given nucleic acid sequence to be identified.

Colonies

The method of the present invention allows one or more distinct areas to be provided, each distinct area comprising a plurality of immobilised nucleic acid strands (hereafter called "colonies"). These areas can contain large numbers of amplified nucleic acid molecules. These molecules may be DNA and/or RNA molecules and may be provided in single or double stranded form. Both a given strand and its complementary strand can be provided in amplified form in a single colony.

Colonies of any particular size can be provided.

However, preferred colonies measure from 10nm to 100µm across their longest dimension, more preferably from 100nm to 10µm across their longest dimension. Desirably a majority of the colonies present on a surface (i.e. at least 50% thereof) have sizes within the ranges given above.

Colonies can be arranged in a predetermined manner or can be randomly arranged. Two or three dimensional colony configurations are possible. The configurations may be regular (e.g. having a polygonal outline or having a generally circular outline) or they may be irregular.

Colonies can be provided at high densities. Densities of over one colony/mm² of surface can be achieved. Indeed densities of over 10², over 10³ or even over 10⁴ colonies/mm² are achievable using the present invention. In preferred embodiments, the present invention provides colony densities of 10⁴⁻⁵ colonies/mm², more preferably densities of 10⁶⁻⁷ colonies/mm², thus offering an improvement of 3 to 4 orders of magnitude relative to densities achievable using many of the prior art methods. It is this property of the invention that allows a great advantage over prior art, since the high density of DNA colonies allows a large number of diverse DNA templates (up to 10⁶⁻⁷ colonies/mm², to be randomly arrayed and amplified.

Primers

The immobilised primers for use in the present invention can be provided by any suitable means, as long as a free 3'-OH end is available for primer extension. Where many different nucleic acid molecules are to be amplified, many different primers may be provided. Alternatively "universal" primers may be used, whereby only one or two different types of primer (depending upon the embodiment of the invention) can be used to amplify the different nucleic acid molecules. Universal primers can be used where the molecules to be amplified comprise first and second sequences, as described previously. The provision of universal primers is advantageous over methods such as those disclosed in WO96/04404 (Mosaic Technologies, Inc.) where specific primers must be prepared for each particular sequence to be amplified.

Synthetic oligodeoxynucleotide primers are available commercially from many suppliers (e.g. Microsynth, Switzerland, Eurogentech, Belgium).

Grafting of primers onto silanized glass or quartz and grafting of primers onto silicon wafers or gold surface has been described (Maskos, U. and E.M Southern, Oligonucleotide hybridizations on glass supports: a novel linker for oligonucleotide synthesis and hybridization properties of oligonucleotides synthesised in situ, *Nucleic Acids Research* 20(7):1679-84, 1992; Lamture, J.B., et.al. Direct-detection of nucleic-acid hybridization on the surface of a

charge-coupled-device, *Nucleic Acids Research* 22(11):2121-2125, 1994; Chrisey, L.A., G.U. Lee, and C.E. Oferrall, Covalent attachment of synthetic DNA to self-assembled monolayer films, *Nucleic Acids Research* 24(15):3031-3039, 1996).

Grafting biotinylated primers to supports covered with streptavidin is another alternative. This grafting method is commonly used for bio-macromolecules in general.

Non covalent grafting of primers at the interface between an aqueous phase and a hydrophobic phase through an hydrophobic anchor is also possible for the present invention. Such anchoring is commonly used for bio-macromolecules in general (S. Terrettaz et al. : Protein binding to supported lipid membranes, *Langmuir* 9,1361 (1993)). Preferred forms of such interfaces would be liposomes, lipidic vesicles, emulsions, patterned bilayers, Langmuir or Langmuir-Blodgett films. The patterns may be obtained by directed patterning on templates, e.g., silicon chips patterned through micro-lithographic methods (Goves, J.T. et al., Micropatterning Fluid Bilayers on Solid Supports, in *Science* 275,651 (1997)). The patterns may also be obtained by due to the self-assembly properties of "colloids", e.g., emulsions or latex particles (Larsen, A.E. and D.G. Grier, Like charge attractions in metastable colloidal crystallites, *Nature* 385,230 (1997)).

In the above methods, one, two or more different primers can be grafted onto a surface. The primers can be grafted homogeneously and simultaneously over the surface.

Using microlithographic methods it is possible to provide immobilised primers in a controlled manner. If direct synthesis of oligonucleotides onto a solid support with a free 3'-OH end is desired, then micro-lithographic methods can be used to simultaneously synthesise many different oligonucleotide primers (Pirrung, M.C. and Bradley, J.C. Comparison of methods for photochemical phosphoramidite-based DNA- synthesis. *Journal Of Organic Chemistry* 60(20):6270-6276, 1995). These may be provided in distinct areas that may correspond in configuration to colonies to be

formed, (e.g. they may be several nanometers or micrometers across). Within each area, only a single type of primer oligonucleotide need be provided. Alternatively a mixture comprising a plurality of different primers may be provided. In either case, primers can be homogeneously distributed within each area. They may be provided in the form of a regular array.

Where areas initially comprise only one type of immobilised primer they may be modified, if desired, to carry two or more different types of primer. One way to achieve this is to use molecules as templates for primer extension that have 3' ends that hybridise with a single type of primer initially present and that have 5' ends extending beyond the 3' ends of said primers. By providing a mixture of templates with different sequences from one another, primer extension of one type of primer using the mixture of such templates followed by strand separation will result in different modified primers. (The modified primers are referred to herein as "extended" primers in order to distinguish from the "primary" primers initially present on a surface).

One, two or more different types of extended primer can be provided in this manner at any area where primary primers are initially located. Substantially equal portions of different templates can be used, if desired, in order to provide substantially equal proportions of different types of immobilised extended primer over a given area. If different proportions of different immobilised extended primers are desired, then this can be achieved by adjusting the proportions of different template molecules initially used accordingly.

A restriction endonuclease cleavage site may be located within the primer. A primer may also be provided with a restriction endonuclease recognition site which directs DNA cleavage several bases distant (Type II restriction endonucleases). (For the avoidance of doubt, such sites are deemed to be present even if the primer and its complement are required to be present in a double stranded molecule for recognition and/or cleavage to occur.) Alternatively a cleavage site and/or a recognition site may be produced when a primer is extended. In any event, restriction endonucleases can be useful in allowing an immobilised nucleic acid molecule within a colony to

be cleaved so as to release at least a part thereof. As an alternative to using other restriction endonucleases, ribozymes can be used to release at least parts of nucleic acid molecules from a surface (when such molecules are RNA molecules). Other methods are possible. For example if a covalent bond is used to link a primer to a surface this bond may be broken (e.g. by chemical, physical or enzymatic means).

Primers for use in the present invention are preferably at least five bases long. Normally they will be less than 100 or less than 50 bases long. However this is not essential. Naturally occurring and/or non-naturally occurring bases may be present in the primers.

Target Nucleic Acid Molecules

Turning now to target nucleic acid molecules (also referred to herein as "templates") for use in the method of the present invention, these can be provided by any appropriate means. A target molecule (when in single-stranded form) comprises a first part having a sequence that can anneal with a first primer and a second part having a sequence complementary to a sequence that can anneal with a second primer. In a preferred embodiment the second part has the same sequence as the second primer.

The second primer may have a sequence that is the same as, or different from, the sequence of the first primer.

The first and second parts of the target nucleic acid molecules are preferably located at the 3' and at the 5' ends respectively thereof. However this is not essential. The target molecule will usually also comprise a third part located between the first and second parts. This part of the molecule comprises a particular sequence to be replicated. It can be from any desired source and may have a known or unknown (sometimes referred to as "anonymous") sequence. It may be derived from random fractionation by mechanical means or by limited restriction enzyme digestion of a nucleic acid sample, for example.

Further parts of the target molecules may be provided if desired. For example parts designed to act as tags may be provided. A "tag" is defined by its function of enabling a particular nucleic acid molecule (or its complement) to be identified.

Whatever parts are present, target nucleic acid molecules can be provided by techniques known to those skilled in the art of nucleic acid manipulation. For example, two or more parts can be joined together by ligation. If necessary, prior to ligation appropriate modifications can be made to provide molecules in a form ready for ligation. For example if blunt end ligation is desired then a single-strand specific exonuclease such as S1 nuclease could be used to remove single stranded portions of molecules prior to ligation. Linkers and/or adapters may also be used in nucleic acid manipulation. (Techniques useful for nucleic acid manipulation are disclosed in Sambrook et al, *Molecular Cloning*, 2nd Edition, Cold Spring Harbor Laboratory Press (1989), for example.)

Once a template molecule has been synthesised it can be cloned into a vector and can be amplified in a suitable host before being used in the present invention. It may alternatively be amplified by PCR. As a further alternative, batches of template molecules can be synthesised chemically using automated DNA synthesisers (e.g. from Perkin-Elmer/Applied Biosystems, Foster City, CA).

It is however important to note that the present invention allows large numbers of nucleic acid molecules identical in sequence to be provided in a colony arising from a single molecule of template. Furthermore, the template can be re-used to generate further colonies. Thus it is not essential to provide large numbers of template molecules to be used in colony formation.

The template can be of any desired length provided that it can participate in the method of the present invention. Preferably it is at least 10, more preferably at least 20 bases long. More preferably it is at least 100 or at least 1000 bases long. As is the case for primers for use in the present invention, templates may comprise naturally occurring and/or non-naturally occurring bases.

Reaction Conditions

Turning now to reaction conditions suitable for the method of the present invention, it will be appreciated that the present invention uses repeated steps of annealing of primers to templates, primer extension and separation of extended primers from templates. These steps can generally be performed using reagents and conditions known to those skilled in PCR (or reverse transcriptase plus PCR) techniques. PCR techniques are disclosed, for example, in "PCR: Clinical Diagnostics and Research", published in 1992 by Springer-Verlag.

Thus a nucleic acid polymerase can be used together with a supply of nucleoside triphosphate molecules (or other molecules that function as precursors of nucleotides present in DNA/RNA, such as modified nucleoside triphosphates) to extend primers in the presence of a suitable template.

Excess deoxyribonucleoside triphosphates are desirably provided. Preferred deoxyribonucleoside triphosphates are abbreviated; dTTP (deoxythymidine nucleoside triphosphate), dATP (deoxyadenosine nucleoside triphosphate), dCTP (deoxycytosine nucleoside triphosphate) and dGTP (deoxyguanosine nucleoside triphosphate). Preferred ribonucleoside triphosphates are UTP, ATP, CTP and GTP. However alternatives are possible. These may be naturally or non-naturally occurring. A buffer of the type generally used in PCR reactions may also be provided.

A nucleic acid polymerase used to incorporate nucleotides during primer extension is preferably stable under the pertaining reaction conditions in order that it can be used several times. (This is particularly useful in automated amplification procedures.) Thus, where heating is used to separate a newly synthesised nucleic acid strand from its template, the nucleic acid polymerase is preferably heat stable at the temperature used. Such heat stable polymerases are known to those skilled in the art. They are obtainable from thermophilic micro-organisms. They include the DNA dependent DNA polymerase known as *Taq* polymerase and also thermostable derivatives thereof. (The nucleic acid polymerase need not however be DNA

dependent. It may be RNA dependent. Thus it may be a reverse transcriptase - i.e. an RNA dependent DNA polymerase.)

Typically, annealing of a primer to its template takes place at a temperature of 25 to 90°C. Such a temperature range will normally be maintained during primer extension. Once sufficient time has elapsed to allow annealing and also to allow a desired degree of primer extension to occur, the temperature can be increased, if desired, to allow strand separation. At this stage the temperature will typically be increased to a temperature of 60 to 100°C. [High temperatures can also be used to reduce non-specific priming problems prior to annealing. They can be used to control the timing of colony initiation, e.g. in order to synchronise colony initiation for a number of samples.] Alternatively, the strands maybe separated by treatment with a solution of low salt and high pH (> 12) or by using a chaotropic salt (e.g. guanidinium hydrochloride) or by an organic solvent (e.g. formamide).

Following strand separation (e.g. by heating), preferably a washing step will be performed. The washing step can be omitted between initial rounds of annealing, primer extension and strand separation, if it is desired to maintain the same templates in the vicinity of immobilised primers. This allows templates to be used several times to initiate colony formation. (It is preferable to provide a high concentration of template molecules initially so that many colonies are initiated at one stage.)

The size of colonies can be controlled, e.g. by controlling the number of cycles of annealing, primer extension and strand separation that occur. Other factors which affect the size of colonies can also be controlled. These include the number and arrangement on a surface of immobilised primers, the conformation of a support onto which the primers are immobilised, the length and stiffness of template and/or primer molecules, temperature and the ionic strength and viscosity of a fluid in which the above-mentioned cycles can be performed.

Uses of Colonies

Once colonies have been formed they can be used for any desired purpose.

For example, they may be used in nucleic acid sequencing (whether partial or full), in diagnosis, in screening, as supports for other components and/or for research purposes (preferred uses will be described in greater detail later on). If desired colonies may be modified to provide different colonies (referred to herein as "secondary colonies" in order to distinguish from the "primary colonies" initially formed).

Surfaces Comprising Immobilised Nucleic Acid Strands

A surface comprising immobilised nucleic acid strands in the form of colonies of single stranded nucleic acid molecules is also within the scope of the present invention.

Normally each immobilised nucleic acid strand within a colony will be located on the surface so that an immobilised and complementary nucleic acid strand thereto is located on the surface within a distance of the length of said immobilised nucleic acid strand (i.e. within the length of one molecule). This allows very high densities of nucleic acid strands and their complements to be provided in immobilised form. Preferably there will be substantially equal proportions of a given nucleic acid strand and its complement within a colony. A nucleic acid strand and its complement will preferably be substantially homogeneously distributed within the colony.

It is also possible to provide a surface comprising single stranded nucleic acid strands in the form of colonies, where in each colony, the sense and anti-sense single strands are provided in a form such that the two strands are no longer at all complementary, or simply partially complementary. Such surfaces are also within the scope of the present invention. Normally, such surfaces are obtained after treating primary colonies, e.g., by partial digestion by restriction enzymes or by partial digestion after strand separation (e.g., after

heating) by an enzyme which digests single stranded DNA), or by chemical or physical means, (e.g., by irradiating with light colonies which have been stained by an intercalating dye e.g., ethidium bromide).

Once single stranded colonies have been provided they can be used to provide double stranded molecules. This can be done, for example, by providing a suitable primer (preferably in solution) that hybridises to the 3' ends of single stranded immobilised molecules and then extending that primer using a nucleic acid polymerase and a supply of nucleoside triphosphates (or other nucleotide precursors).

Thus surfaces comprising colonies of non-bridged double stranded nucleic acid molecules are also within the scope of the present invention. (The term "non-bridged" is used here to indicate that the molecules are not in the form of the bridge-like structures shown in e.g. figure 1h.)

Using the present invention, small colonies can be provided that contain large numbers of nucleic acid molecules (whether single or double stranded). Many colonies can therefore be located on a surface having a small area. Colony densities that can be obtained may therefore be very high, as discussed *supra*.

Different colonies will generally be comprised of different amplified nucleic acid strands and amplified complementary strands thereto. Thus the present invention allows many different populations of amplified nucleic acid molecules and their complements to be located on a single surface having a relatively small surface area. The surface will usually be planar, although this is not essential.

Apparatuses

The present invention also provides an apparatus for providing a surface comprising colonies of the immobilised nucleic acid molecules discussed *supra*.

Such an apparatus can include one or more of the following:

- a) means for immobilising primers on a surface (although this is not needed if immobilised primers are already provided);
 - b) a supply of a nucleic acid polymerase;
 - c) a supply of precursors of the nucleotides to be incorporated into a nucleic acid (e.g. a supply of nucleoside triphosphates);
 - d) means for separating annealed nucleic acids (e.g. heating means);
- and
- e) control means for co-ordinating the different steps required for the method of the present invention.

Other apparatuses are within the scope of the present invention. These allow immobilised nucleic acids produced via the method of the present invention to be analysed. They can include a source of reactants and detecting means for detecting a signal that may be generated once one or more reactants have been applied to the immobilised nucleic acid molecules. They may also be provided with a surface comprising immobilised nucleic acid molecules in the form of colonies, as described *supra*.

Desirably the means for detecting a signal has sufficient resolution to enable it to distinguish between signals generated from different colonies.

Apparatuses of the present invention (of whatever nature) are preferably provided in automated form so that once they are activated, individual process steps can be repeated automatically.

The present invention will now be described without limitation thereof in sections A to I below with reference to the accompanying drawings.

It should be appreciated that procedures using DNA molecules referred to in these sections are applicable *mutatis mutandis* to RNA molecules, unless the context indicates otherwise.

It should also be appreciated that where sequences are provided in the following description, these are written from 5' to 3' (going from left to right), unless the context indicates otherwise.

The figures provided are summarised below:

FIGURE 1 illustrates a method for the simultaneous amplification and immobilisation of nucleic acid molecules using a single type of primer.

FIGURE 2 illustrates how colony growth using a method of the present invention can occur.

FIGURE 3 illustrates the principle of the method used to produce DNA colonies using the present invention. It also illustrates the annealing, elongation and denaturing steps that are used to provide such colonies.

FIGURE 4 is an example of DNA colonies formed by amplification of a specific template with single primers grafted onto a surface.

FIGURE 5 illustrates a method for the simultaneous amplification and immobilisation of nucleic acid molecules using two types of primer.

FIGURE 6 shows actual DNA colonies produced via the present invention.

FIGURE 7 illustrates a method of the simultaneous amplification and immobilisation of nucleic acid molecules when a target molecule is used as a template having internal sequences that anneal with primers.

Figure 8 illustrates a method to synthesise additional copies of the original nucleic acid strands using nucleic acid strands present in colonies. The newly synthesised strands are shown in solution but can be provided in immobilised form if desired.

Figure 9 shows the PCR amplification of DNA from DNA found in the pre-formed DNA colonies.

FIGURE 10 illustrates how secondary primers can be generated from DNA colonies.

FIGURE 11 illustrates how secondary DNA colonies can be generated from secondary primers.

FIGURE 12 illustrates how primers with different sequences can be generated from a surface functionalised with existing primers.

FIGURE 13 depicts methods of preparing DNA fragments suitable for generating DNA colonies.

FIGURE 14 illustrates a method for synthesising cRNA using the DNA colony as a substrate for RNA polymerase.

FIGURE 15 illustrates a preferable method to determine the DNA sequence of DNA present in individual colonies.

FIGURE 16 illustrates a method of determining the sequence of a DNA colony, *de novo*.

FIGURE 17 illustrates the utility of secondary DNA colonies in the assay of mRNA expression levels.

FIGURES 18 and 19 illustrates the use of the secondary DNA colonies in the isolation and identification of novel and rare expressed genes.

A) Scheme Showing The Simultaneous Amplification And
Immobilisation Of Nucleic Acid Molecules Using A Single Type Of
Primer

Referring now to Figure 1a), a surface is provided having attached thereto a plurality of primers (only one primer is shown for simplicity). Each primer (1) is attached to the surface by a linkage indicated by a dark block. This may be a covalent or a non-covalent linkage but should be sufficiently strong to keep a primer in place on the surface. The primers are shown having a short nucleotide sequence (5'-ATT). In practice however longer sequences would generally be provided.

Figure 1b) shows a target molecule (II) that has annealed to a primer. The target molecule comprises at its 3' end a sequence (5'-ATT) that is complementary to the primer sequence (5'-ATT). At its 5' end the target molecule comprises a sequence (5'-ATT) that is the same as the primer sequence (although exact identity is not required).

Between the two ends any sequence to be amplified (or the complement of any sequence to be amplified) can be provided. By way of example, part of the sequence to be amplified has been shown as 5'-CCG.

In Figure 1c) primer extension is shown. Here a DNA polymerase is used together with dATP, dTTP, dGTP and dCTP to extend the primer (5'-ATT) from its 3' end, using the target molecule as a template.

When primer extension is complete, as shown in Figure 1d), it can be seen that an extended immobilised strand (III) is provided that is complementary to the target molecule. The target molecule can then be separated from the extended immobilised strand (e.g. by heating, as shown in Figure 1e)). This separation step frees the extended, immobilised strand so that it can then be used to initiate a subsequent round of primer extension, as shown in Figures 1f) and 1g)

Here the extended, immobilised strand bends over so that one end of that strand (having the terminal sequence 5'-AAT) anneals with another primer (2, 5'-ATT), as shown in Figure 1f). That primer provides a 3' end from which primer extension can occur, this time using the extended, immobilised strand as a template. Primer extension is shown occurring in Figure 1g) and is shown completed in Figure 1h).

Figure 1i) shows the two extended immobilised strands that were shown in Figure 1h) after separation from one another (e.g. by heating). Each of these strands can then themselves be used as templates in further rounds of primer extension initiated from new primers (3 and 4), as shown in Figures 1j) and 1k). Four single stranded, immobilised strands can be provided after two rounds of amplification followed by a strand separation step (e.g. by heating), as shown in Figure 1l). Two of these have sequences corresponding to the sequence of the target molecule originally used as a template. The other two have sequences complementary to the sequence of the target molecule originally used as a template. (In practice a given immobilised strand and its immobilised complement may anneal once.)

It will therefore be appreciated that a given sequence and its complement can be provided in equal numbers in immobilised form and can be substantially homogeneously distributed within a colony.

Further rounds of amplification beyond those shown in Figure 1 can of course be performed so that colonies comprising large numbers of a given single stranded nucleic acid molecule and a complementary strand thereto can be provided. Only a single template need be used to initiate each colony, although, if desired, a template can be re-used to initiate several colonies.

It will be appreciated that the present invention allows very high densities of immobilised extended nucleic acid molecules to be provided. Within a colony each extended immobilised molecule will be located at a surface within one molecule length of another extended immobilised molecule. Thus position 3 shown in Figure 1l) is within one molecule length of position 1; position 1 is within one molecule

length of position 2; and position 2 is within one molecule length of position 4.

Figure 2 is provided to illustrate how colony growth can occur (using the method described with reference to Figure 1 and to Figure 6 or any other method of the present invention for providing immobilised nucleic acid molecules).

A flat plate is shown schematically in plan view having primers immobilised thereon in a square grid pattern (the primers are indicated by small dots). A regular grid is used solely for simplicity: in many real cases, the positions of the primers might indeed be less ordered or random.

At the position indicated by arrow X a template molecule has annealed to a primer and an initial bout of primer extension has occurred to provide an immobilised, extended nucleic acid strand. Following strand separation, an end of that strand becomes free to anneal to further primers so that additional immobilised, extended nucleic acid strands can be produced. This is shown having occurred sequentially at positions indicated by the letter Y. For simplicity, the primer chosen for annealing is positioned next to the primer carrying the nucleic acid strand: in real cases, the nucleic acid strand could anneal with a primer which is not its next nearest neighbour. However, this primer will obviously be within a distance equal to the length of the nucleic acid strand.

It will be appreciated that annealing at only one (rather than at all) of these positions is required for colony cell growth to occur.

After immobilised, extended, single-stranded nucleic acid molecules have been provided at the positions indicated by letter Y, the resultant molecules can themselves anneal to other primers and the process can be continued to provide a colony comprising a large number of immobilised nucleic acid molecules in a relatively small area.

Figure 3 shows a simplified version of the annealing, elongation and denaturing cycle. It also depicts the typical observations that can be made, as can be seen on the examples shown in figures 4 and 6. The simultaneous amplification and immobilisation of nucleic acids using solid phase primers has been successfully achieved using the procedure described in Examples 1, 2 and 3 below:

EXAMPLE 1

Oligonucleotides, phosphorylated at their 5'-termini (Microsynth GmbH, Switzerland), were grafted onto Nucleolink plastic microtitre wells (Nunc, Roskilde, Denmark). The sequence of the oligonucleotide p57 corresponds to the sequence 5'-TTTTTTCACCAACCCAAACCAACCCAAACC and p58 corresponds to the sequence 5'-TTTTTTAGAAGGAGAAGGAAAGGGAAAGGG. Microtitre wells with p57 or p58 were prepared as follows. In each Nucleolink well, 30 µl of a 160nM solution of the oligonucleotide in 10 mM 1-methyl-imidazole (pH 7.0) (Sigma Chemicals, St.Louis, MO) was added. To each well, 10 µl of 40 mM 1-ethyl-3-(3-dimethylaminopropyl)-carbodiimide (pH 7.0) (Sigma Chemicals) in 10 mM 1-methyl-imidazole, was added to the solution of oligonucleotides. The wells were then sealed and incubated at 50 °C overnight. After the incubation, wells were rinsed twice with 200 µl of RS (0.4N NaOH, 0.25% Tween 20 (Fluka Chemicals, Switzerland)), incubated 15 minutes with 200 µl RS, washed twice with 200 µl RS and twice with 200 µl TNT (100mM TrisHCl pH7.5, 150mM NaCl, 0.1% Tween 20). Tubes were dried at 50°C and were stored in a sealed plastic bag at 4°C.

Colony generation was initiated in each well with 15 µl of priming mix; 1 nanogram template DNA (where the template DNA began with the sequence 5'-AGAAGGAGAAGGAAAGGGAAAGGG and terminated at the 3'-end with the sequence CCCTTCCCTTCTCTCTCT-3'), the four dNTPs (0.2 mM), 0.1% BSA (bovine serum albumin, Boehringer-Mannheim, Germany), 0.1% Tween 20, 8% DMSO (dimethylsulfoxide, Fluka Chemicals, Switzerland), 1X Amplitaq PCR buffer and 0.025 units/µl of AmpliTaQ DNA polymerase (Perkin Elmer, Foster City, CA). The priming reaction was a single round of PCR under the following conditions; 94°C for 4 minutes, 60°C for 30 seconds and 72°C for 45 seconds in a

thermocycler (PTC 200, MJ Research, Watertown, MA). Then 100 μ l TE buffer (10mM trisHCl, pH 7.5, 1mM EDTA) was used in three successive one minute long washes at 94°C. The DNA colonies were then formed by adding to each well, 20 μ l of polymerisation mix, which was identical to the priming mix but lacking the template DNA. The wells were then placed in the PTC 200 thermocycler and colony growing was performed by incubating the sealed wells 4 minutes at 94°C and cycling for 50 repetitions the following conditions: 94°C for 45 seconds, 65°C for 2 minutes, 72°C for 45 seconds. After completion of this program, the wells were kept at 8°C until further use.

A 640 base pair fragment corresponding to the central sequence of the template (but not including the 5'-AGAAGGAGAAGGAAAGGGAAAGGG sequence) was amplified by PCR. The isolated fragment was labelled with biotin-N⁴-dCTP (NEN Life Sciences, Boston, MA) and a trace of [α -³²P]dCTP (Amersham, UK) using the Prime-it II labelling kit (Stratagene, San Diego, CA) to generate a biotinylated probe.

The biotinylated probe was diluted in to a concentration of 2.5 nM in EasyHyb (Boehringer-Mannheim, Germany) and 15 μ l was hybridized to each sample with the following temperature scheme (PTC 200 thermocycler): 94°C for 5 minutes, followed by 500 steps of 0.1°C decrease in temperature every 12 seconds (in other words, the temperature is decreased down to 45°C in 100 minutes). The samples are then washed as follows; 1 time with 2X SSC/0.1% SDS (2X SSC; 0.3M NaCl/0.03M sodium citrate pH7.0/0.001 mg/ml sodium dodecyl sulfate) at room temperature, once with 2X SSC/0.1% SDS at 37°C and once with 0.2X SSC/0.1% SDS at 50°C. The wells are then incubated for 30 minutes with 50 μ l of red fluorescent, Neutravidin-coated, 40 nm FluoSpheres^(R) (580 nm excitation and 605 nm emission, Molecular Probes Inc., Eugene, OR) in TNT/0.1% BSA. (The solution of microspheres is made from a dilution of 2 μ l of the stock solution of microspheres into 1ml of TNT/0.1% BSA, which is then sonicated for 5 minutes in a 50 W ultra-sound water-bath (Elgasonic, Switzerland), followed by filtration through a 0.22 μ m filter (Millex GV4). The wells are then counted (Cherenkov) on a Microbeta plate scintillation counter (WALLAC, Turku, Finland).

Excess FluoSpheres^(R) are removed by washing for 30 min in TNT/0.1%BSA at room temperature. Images of the stained samples are observed using a 20X objective on an inverted microscope (Axiovert S100TV, Carl Zeiss AG, Oberkochen, Germany) equipped with a Micromax 512x768 CCD camera (Princeton instruments, Trenton, NJ) through a XF43 filter set (PB546/FT580/LP590, Omega Optical, Brattleboro, VT) with a 5 second exposure.

Figure 4 shows the hybridisation results for colony generation on tubes functionalised with either; (a) oligonucleotide p57 or (b) oligonucleotide p58. The control reaction shows very few fluorescent spots, since the sequence of the flanking regions on the template do not correspond to the primer sequences grafted onto the well. In contrast, figure 4b shows the number of fluorescent spots detected when the primers grafted to the wells match the flanking sequences on the initiating DNA template. Calculating the number of fluorescent spots detected and taking into consideration the magnification, we can estimate that there are between 3 and 5 x 10⁷ colonies/cm². The photos are generated by the program, Winview 1.6.2 (Princeton Instruments, Trenton, NJ) with backgrounds and intensities normalised to the same values.

B) Scheme Showing The Simultaneous Amplification And
Immobilisation Of Nucleic Acid Molecules Using Two Different
Types of Primer

Referring now to Figure 5, another embodiment of the present invention is illustrated. Here two different immobilised primers are used to provide primer extension.

In this embodiment the target molecule shown is provided with a nucleotide sequence at its 3' end (AAT-3') that is complementary to the sequence of a first primer, (5'-ATT, I), which is grafted on the surface, so that annealing with that primer can occur. The sequence (5'-GGT) at the 5' end of the target molecule, III, corresponds to the sequence (5'-GGT) of a second primer, II, which is also grafted to the surface, so that the sequence which is complementary to the sequence at the 5' end can anneal with that said second primer. Generally said complementary sequence (5'-ACC) is chosen so that it will not anneal with the first primer (5'-ATT). Unlike the situation described in section A, once the 3' end of a newly synthesised strand anneals to a primer on the surface, it will have to find a primer whose sequence is different from the sequence it carries at its 5' end (see the difference between Figures 1f and 5f).

The embodiment shown in Figure 5 has an advantage over the embodiment illustrated in Figure 1 since the possibility of one end of a single stranded target molecule annealing with another end of the same molecule in solution can be avoided and therefore amplification can proceed further. The possibility of annealing occurring between both ends of an immobilised complement to a target molecule can also be avoided.

EXAMPLE 2

A mix of two oligonucleotides which are phosphorylated at the 5'-end (Microsynth GmbH, Balgach, Switzerland) have been grafted on 96 well Nucleolink plates (Nunc, Denmark) as recommended by the manufacturer. The resulting plates has been stored dry at 4°C. The sequence of the primer, P1, was 5'-GCGCGTAATACGACTCACTA, the sequence of the other primer, P2, was 5'-CGCAATTAACCCTCACTAAA. These plates are specially formulated by Nunc, allowing the covalent grafting of 5'-phosphorylated DNA fragments through a standard procedure.

A template has been cloned in a vector (pBlueScript Skminus, Stratagene Inc, San Diego, CA) with the appropriate DNA sequence at the cloning site (i.e., corresponding to P1 and P2 at position 621 and 794 respectively), and 174 bp long linear double stranded DNA template has been obtained by PCR amplification, using P1 and P2. The template PCR product has been purified on Qiagen Qia-quick columns (Qiagen GmbH, Hilden, Germany) in order to remove the nucleotides and the primers used during the PCR amplification.

The purified template (in 50 µl solution containing 1X PCR buffer (Perkin Elmer, Foster City, CA) with the four deoxyribonucleoside triphosphates (dNTPs) at 0.2 mM, (Pharmacia, Uppsala, Sweden) and 2.5 units of AmpliTaq Gold DNA polymerase (Perkin Elmer, Foster City, CA)) has been spread on the support, i.e. on the Nucleolink plates grafted with P1 and P2 (the plates have been rinsed with a solution containing 100 mM TRIS-HCl (pH 7.5), 150 mM NaCl and 0.1% Tween 20 (Fluka, Switzerland) at room temperature for 15 min). This solution has been incubated at 93°C for 9 minutes to activate the DNA polymerase and then 60 cycles (94°C/30 sec., 48°C/30 sec., 72°C/30 sec.) have been performed on a PTC 200 thermocycler. Several different concentrations of PCR template have been tested (approximately 1, 0.5, 0.25, 0.125, 0.0625 ng/µl) and for each sample a control reaction carried out without Taq polymerase has been performed (same conditions as above but without DNA polymerase).

Each sample has been stained with YO-PRO (Molecular Probes, Portland OR), a highly sensitive stain for double stranded DNA. The resulting products have been observed on a confocal microscope using a 40X objective (LSM 410, Carl Zeiss AG, Oberkochen, Germany) with

appropriate excitation (an 488 argon laser) and detection filters (510 low pass filter) (note: the bottom of each well is flat and allows observation with an inverted fluorescence microscope).

In figure 6A, the control well (without added DNA template, panel a) shows only rare objects which can be observed on a blank surface (these objects were useful at this stage for reporting that the focus was correct). These objects have an irregular shape, are 20 to 100 micro-meters in size and have a thickness much larger than the field depth of the observation. In a well where DNA polymerase was present (figure 6A, panel ii), in addition to the objects of irregular shape observed in the control well, a great number of fluorescent spots can be observed. They present a circular shape, they are 1 to 5 micro meters in size and do not span the field of view. The number of spots depends on the concentration of the template used for initiating colony formation. From the observed size of the colonies, one can estimate that more than 10,000 distinct colonies can be arrayed within 1 mm² of support.

EXAMPLE 3

Oligonucleotides (Microsynth GmbH, Switzerland) were grafted onto Nucleolink wells (Nunc, Denmark). Oligonucleotide P1 corresponds to the sequence 5'-TTTTTCTCACTATAGGGCGAATTGG and oligonucleotide P2 corresponds to 5'-TTTTTCTCACTAAAGGGAACAAAAGCTGG. In each Nucleolink well, a 45 µl of 10 mM 1-methyl-imidazole (pH 7.0) (Sigma Chemicals, St.Louis, MO) solution containing 360 fmol of P1 and 360 fmol of P2 was added. To each well, 15 µl of 40 mM 1-ethyl-3-(3-dimethylaminopropyl)-carbodiimide (pH 7.0) (Sigma Chemicals) in 10 mM 1-methyl-imidazole, was added to the solution of oligonucleotides. The wells were then sealed and incubated at 50°C for 16 hours. After the incubation, wells have been rinsed twice with 200 µl of RS (0.4N NaOH, 0.25% Tween 20), incubated 15 minutes with 200 µl RS, washed twice with 200 µl RS, and twice with 200µl TNT (100mM Tris/HCl pH7.5, 150mM NaCl, 0.1% Tween 20), before they are put to dry at 50°C in an oven. The dried tubes were stored in a sealed plastic bag at 4°C.

Colony growing was initiated in each well with 15 μ l of initiation mix (1X PCR buffer, 0.2 mM dNTPs and 0.75 units of AmpliTaq Gold DNA polymerase, 20 nanograms of template DNA, where the template DNA was either S1 DNA or S2 DNA or a mixture of different ratios of S1 DNA and S2 DNA, as indicated in discussion to figure 6B. S1 and S2 are 704 base pair and 658bp fragments, respectively, which have been cloned into pBlueScript Skminus plasmids and subsequently amplified through a PCR using P1 and P2 as primers. The fragments were purified on Qiagen Qia-quick columns (QIAGEN GmbH, Germany) in order to remove the nucleotides and the primers.

Each well was sealed with Cycleseal™ (Robbins Scientific Corp., Sunnyvale, CA), and incubated at 93 °C for 9 minutes, 65°C for 5 minutes and 72°C for 2 minutes and back to 93°C. Then 200 μ l TNT solution was used in three successive one minute long washes at 93°C. The initiation mix was then replaced by 15 μ l growing mix (same as initiation mix, but without template DNA), and growing was performed by incubating the sealed wells 9 minutes at 93 °C and repeating 40 times the following conditions: 93°C for 45 seconds, 65°C for 3 minutes, 72 °C for 2 minutes. After completion of this program, the wells were kept at 6°C until further use. The temperature control was performed in a PTC 200 thermo-cycler, using the silicon pad provided in the Nucleolink kit and the heated (104°C) lid of the PTC 200.

A 640base pair fragment corresponding to the central sequence of the S1 fragment, but not including the P1 or P2 sequence was amplified by PCR as previously described. The probe was labelled with biotin-16-dUTP (Boehringer-Mannheim, Germany) using the Prime-it II random primer labelling kit (Stratagene, San Diego, CA) according to the manufacturers instructions.

The biotinylated probes were hybridized to the samples in EasyHyb buffer (Boehringer-Mannheim, Germany), using the following temperature scheme (in the PTC 200 thermocycler): 94°C for 5 minutes, followed by 68 steps of 0.5°C decrease in temperature every 30 seconds (in other words, the temperature is decreased down to 60 °C in 34 minutes), using sealed wells. The samples are then washed 3 times with 200 μ l of TNT at room temperature. The wells are then

incubated for 30 minutes with 50 μ l TNT containing 0.1 mg/ml BSA. Then the wells are incubated 5 minutes with 15 μ l of solution of red fluorescent, Neutravidin-coated, 40 nm FluoSpheres^(R) (580 nm excitation and 605 nm emission, Molecular Probes, Portland, OR). The solution of microspheres is made of 2 μ l of the stock solution of microspheres, which have been sonicated for 5 minutes in a 50 W ultra-sound water-bath (Elgasonic, Bienne, Switzerland), diluted in 1 ml of TNT solution containing 0.1 mg/ml BSA and filtered with Millex GV4 0.22 μ m pore size filter (Millipore, Bedford, MA).

The stained samples are observed using an inverted Axiovert 10 microscope using a 20X objective (Carl Zeiss AG, Oberkochen, Germany) equipped with a Micromax 512x768 CCD camera (Princeton Instruments, Trenton, NJ), using a XF43 filter set (PB546/FT580/LP590, Omega Optical, Brattleboro, VT), and 10 seconds of light collection. The files are converted to TIFF format and processed in the suitable software (PhotoPaint, Corel Corp., Ottawa, Canada). The processing consisted in inversion and linear contrast enhancement, in order to provide a picture suitable for black and white print-out on a laser printer.

The figure 6B shows the results for 3 different ratios of the S1/S2 templates used in the initiating reaction: i) the S1/S2 is 1/0, many spots can be observed, ii) the S1/S2 is 1/10, and the number of spots is approximately 1/10 of the number of spots which can be observed in the i) image, as expected, and iii) the S1/S2 is 0/1, and only a few rare spots can be seen.

C Scheme Showing Simultaneous Amplification And Immobilisation Of
Nucleic Acid Molecules When The Target Molecule Contains
Internal Sequences Complementary To The Immobilised Primers

Figure 7 is provided to show that the sequences shown at the 5' and 3' ends of the target molecule illustrated in Figures 1 and 5 need not be located at the ends of a target molecule.

A target nucleic acid molecule (II) may have a sequence at each (or either) end that is neither involved in annealing with a primer nor in acting as a template to provide a complementary sequence that anneals with a primer (sequence 5'-AAA and sequence 5'-CCC). One of the internal sequences (5'-AAT) is used as a template to synthesise a complementary sequence, III, thereto (5'-TTT), as is clear from figures 7(a) to 7(e).

The sequence 5'-TTT is not however itself used to provide a sequence complementary thereto, as is clear from figures 7(f) to 7(k). It can be seen from Figure 7(l) that only one of the four immobilised strands shown after two rounds of primer extension and a strand separation step comprises the additional sequence 5'-TTT and that no strand comprising a complementary sequence (5'-AAA) to this sequence is present (i.e. only one strand significantly larger than the others is present). After several rounds of amplification the strand comprising the sequence 5'-TTT will represent an insignificant proportion of the total number of extended, immobilised nucleic acid molecules present.

D) Using Nucleic Acid Strands Present in Colonies to Synthesise Additional Copies of Nucleic Acid Strands

Amplified, single stranded nucleic acid molecules present in colonies provided by the present invention can themselves be used as templates to synthesise additional nucleic acid strands.

Figure 8 illustrates one method of synthesising additional nucleic acids using immobilised nucleic acids as a starting point.

Colonies will usually comprise both a given nucleic acid strand and its complement in immobilised form (figure 8a). Thus they can be used to provide additional copies not only of a given nucleic acid strand but also of its complement.

One way of doing this is to provide one or more primers (primers TTA and TGG) in solution that anneal to amplified, immobilised nucleic acid strands present in colonies (figure 8c) provided by the present invention. (These primers may be the same as primers initially used to provide the immobilised colonies, apart from being provided in free rather than immobilised form.) The original DNA colony is denatured by heat to its single-stranded form (figure 8b), allowing primers TTA and TGG to anneal to the available 3' end of each DNA strand. Primer extension, using AmpliTaq DNA polymerase and the four deoxyribonucleoside triphosphates (labelled or unlabeled) can then be used to synthesise complementary strands to immobilised nucleic acid strands or at least to parts thereof (step (iii)).

Once newly formed strands (figure 8d) have been synthesised by the process described above, they can be separated from the immobilised strands to which they are hybridised (e.g. by heating). The process can then be repeated if desired using the PCR reaction, to provide large number of such strands in solution (figure 8e).

Strands synthesised in this manner, after separation from the immobilised strands, can, if desired, be annealed to one another (i.e. a given strand and its complement can anneal) to provide double-stranded nucleic acid molecules in solution. Alternatively they can be separated from one another to provide homogenous populations of single-stranded nucleic acid molecules in solution.

It should also be noted that once single-stranded molecules are provided in solution they can be used as templates for PCR (or reverse PCR). Therefore it is not essential to continue to use the immobilised nucleic acid strands to obtain further amplification of given strands or complementary strands thereto.

It should be noted that where a plurality of colonies are provided and nucleic acid strands in different colonies have different sequences, it is possible to select only certain colonies for use as templates in the synthesis of additional nucleic acid molecules. This can be done by using primers for primer extension that are specific for molecules present in selected colonies.

Alternatively primers can be provided to allow several or all of the colonies to be used as templates. Such primers may be a mixture of many different primers (e.g. a mixture of all of the primers originally used to provide all of the colonies, but with the primers being provided in solution rather than in immobilised form).

EXAMPLE 4

Oligonucleotides (Microsynth GmbH Balgach, Switzerland) were grafted onto Nucleolink wells (Nunc, Denmark). Oligonucleotide P1 corresponds to the sequence 5'-TTTTTTTTTTCACCAACCCAAACCAACCCAAACC and oligonucleotide P2 corresponds to 5'-TTTTTTTTTTAGAAAGGAGAAGGAAAGGGAAAGGG. In each Nucleolink well, a 45 µl of 10 mM 1-methyl-imidazole (pH 7.0) (Sigma Chemicals) solution containing 360 fmol of P1 and 360 fmol of P2 was added. To each

well, 15 µl of 40 mM 1-ethyl-3-(3-dimethylaminopropyl)-carbodiimide (pH 7.0) (Sigma Chemicals) in 10 mM 1-methyl-imidazole, was added to the solution of oligonucleotides. The wells were then sealed and incubated at 50 °C for 16 hours. After the incubation, wells have been rinsed twice with 200 µl of RS (0.4N NaOH, 0.25% Tween 20), incubated 15 minutes with 200 µl RS, washed twice with 200 µl RS, and twice with 200µl TNT (100mM Tris/HCl pH7.5, 150mM NaCl, 0.1% Tween 20), before they are put to dry at 50°C in an oven. The dried tubes were stored in a sealed plastic bag at 4°C.

Colony growing was initiated in each well with 15 µl of initiation mix (1X PCR buffer, 0.2 mM dNTPs and 0.75 units of AmpliTaq DNA polymerase, 20 nanograms of template DNA, where the template DNA was either S1 DNA or S2 DNA or a 1/1 mixture of S1 DNA and S2 DNA, as indicated in discussion to Example 3. S1 and S2 are 658 base pair and 704 b.p. fragments, respectively, which have been prepared as described in EXAMPLE 3.

Each well was sealed with Cycleseal™ (Robbins Scientific Corp., Sunnyvale, CA) and incubated at 93°C for 9 minutes, 65°C for 5 minutes and 72°C for 2 minutes and back to 93°C. Then 200 µl TNT solution was used in three successive one minute long washes at 93°C. The initiation mix was then replaced by 15 µl growing mix (same as initiation mix, but without template DNA) and growing was performed by incubating the sealed wells 9 minutes at 93°C and repeating 40 times the following conditions: 93°C for 45 seconds, 65°C for 3 minutes, 72°C for 2 minutes. After completion of this program, the wells were kept at 6°C until further use. The temperature control was performed in a PTC 200 thermo-cycler.

Different treatments where applied to 6 sets (A,B,C,D,E and F) of 3 wells (1,2,3), one prepared with template S1, one with template S1 and template S2 and one prepared with template S2 alone (yielding A1,A2,A3,...,F1,F2,F3). The set A was left untreated, set B has been incubated for 10 minutes with BAL-31 exonuclease (New England Biolabs, Beverly, MA) at 37°C in BAL-31 buffer (BAL-31 essentially digests double stranded DNA which has both ends free), set C has been incubated for 10 minutes with S1 nuclease (Pharmacia, Uppsala, Sweden) at 37°C in S1 buffer (S1 nuclease essentially digests single

stranded DNA), set D, E and F have been incubated with both BAL-31 and S1 nucleases. Reactions were stopped by rinsing the wells with TNT buffer.

PCR (25 cycles, 30 sec. at 94°C , 45 sec. at 60°C , 45 sec. at 72°C) has been performed in the Nucleolink wells with 0.25 µM primers P70 (5'-CACCAACCCAAACCAACCCAAACCAGACTCACTATAGGGCGAA) and P71 (5'-AGAAGGAGAAGGAAAGGGAAAGGGTAAAGGGAACAAAAGCTGGA) in solution in sets A, B, C and D. P70 and P71 are suited for the amplification of both S1 and S2, since primer P70 contains the sequence of primer P1 and p71 contains P2. In the set E wells, PCR has been performed with a set of forward (P150, 5'-GGTGCTGGTCCTCAGTCTGT) and reverse (P151, 5'-CCCCTTACCAGTTTCCATT) primers which are within S1 and not within S2 so as to produce a 321 bp PCR product, and in the set F wells, PCR has been performed with a set of forward (P152, 5'-CTGGCCTTATCCCTAACAGC) and reverse (P153, 5'-CGATCTTGGCTCATCACAAT) primers which are within S2 and not within S1 so as to produce a 390 bp PCR product. For each of the 18 PCR reactions, 3 µl of solution have been used for gel electrophoresis on 1% agarose in presence of 0.1 µg/ml ethidium-bromide. The pictures of the gels are presented in Figure 9. These pictures show that DNA in the colonies is protected from exonuclease digestion (sets B, C and D as compared to set A), and that both S1 and S2 can be recovered either simultaneously using P1 and P2 (sets A, B, C and D) or specifically (set E and F). In set E and F, where the shorter PCR products are more efficiently amplified than the longer PCR products in sets A, B, C, D, a cross-contamination between the S1 and S2 templates is detectable (see lane E2 and F1).

E) Provision of Secondary Colonies

It is also possible to modify initially formed colonies to provide different colonies (i.e. to provide colonies comprising immobilised nucleic acid molecules with different sequences from those molecules present in the initially formed colonies). Here, the initially formed colonies are referred to as "primary colonies" and the later formed colonies as "secondary colonies". A preliminary procedure is necessary to turn the primary colonies into "secondary primers" which will be suitable for secondary colony generation.

Figure 10 shows how 'secondary primers' are generated using existing primary colonies. As a starting point, the primary colony (figure 10a) is left in the fully hybridised, double-stranded form. A single-strand specific DNA exonuclease might be used to remove all primers which have not been elongated. One could also choose to cap all free 3'-OH ends of primers with dideoxyribonucleotide triphosphates using a DNA terminal transferase (step (i), figure 10b).

Secondly and independently, the DNA molecules forming the colonies can be cleaved by using endonucleases. For example, a restriction enzyme that recognises a specific site within the colony (depicted by the 'RE' arrow in figure 10c) and cleaves the DNA colony (step (ii), figure 10). If desired, the enzymatically cleaved colony (figure 10d) can then be partially digested with a 3' to 5' double-strand specific exonuclease (e.g. *E.coli* exonuclease III, depicted by 'N', step (iii), figure 10d). In any case, the secondary primers are available after denaturation (e.g., by heat) and washing (figure 10e).

Alternatively, the double stranded DNA forming the colonies (figure 10f) can be digested with the double-strand specific 3'-5' exonuclease, which digest only one strand of double stranded DNA. An important case is when the exonuclease digests only a few bases of

the DNA molecule before being released in solution, and when digestion can proceed when another enzyme binds to the DNA molecule (figure 10g). In this case the exonuclease digestion will proceed until there remain only single stranded molecules which, on average, are half the length of the starting material, and are without any complementary parts (which could form partial duplexes) remaining in the single stranded molecules in a colony (figure 10h).

In all cases, these treatments result in single-stranded fragments grafted onto a support which correspond to the sequence of the original template and that can be used for new DNA colony growing if an appropriate new template is provided for colony initiation (figures 10e and 10h).

The result of such a treatment, thus a support holding secondary primers, will be referred to as a "support for secondary colony growing". Templates useful for secondary colony growing may include molecules having known sequences (or complements of such sequences). Alternatively templates may be derived from unsequenced molecules (e.g. random fragments). In either event the templates should be provided with one or more regions for annealing with nucleic acid strands present in the primary colonies.

Figure 11 a-e show how a secondary colony can be generated when an appropriate template (TP, figure 11a) is provided for a second round of DNA colony generation on a support for secondary colony growing, holding secondary primers. In this example, treatment of the primary colony as described above has generated the secondary primers, SP1 and SP2 (figure 11a). The template TP, will hybridise to its complementary secondary primer, SP1, and following an extension reaction using a DNA polymerase as described, will be extended as depicted (figure 12b). Following a denaturing (step ii), reannealing (step iii) and DNA polymerase (step iv) cycle, a replica of the original primary colony will be formed (figure 11e).

The maximum size of a secondary colony provided by this embodiment of the present invention is restricted by the size of the primary colony onto which it grows. Several secondary growing processes can be used sequentially to create colonies for specific applications (i.e. a first colony can be replaced with a second colony, the second colony can be replaced with a third colony, etc.)

F) Provision of Extended Primers

Figure 12 shows how extended primers can be generated on an array of oligonucleotides. The same procedure could be applied to a support covered with colonies or secondary primers as described in section E.

In Figure 12a) a support is provided having a plurality of immobilised primers shown thereon. Different immobilised primers are shown present in different regions of the support (represented by squares). Primers having the sequence 5'-AAA are present in one square and primers having the sequence 5'-GGG are present in another square.

Figures 12b) to 12d) show how the initial primers present (initial primers) are modified to give different primers (extended primers). In this example, those initial primers having the sequence 5'-AAA are modified to produce two different types of extended primers, having the sequences 5'-AAAGCC and 5'-AAATAC respectively. This is achieved by the hybridisation of oligonucleotide templates, 5'-GTATTT and 5'-GGCTTT to the primary primers immobilised on the surface (figure 12b), followed by DNA polymerase reaction. Those initial primers having the sequence 5'-GGG are modified to produce two different types of extended primers, having the sequences 5'-GGGTAT and 5'-GGGTAA (figure 12d) in a similar manner.

The technique of producing extended primers is useful for transforming immobilised oligonucleotides provided on a DNA chip or other surface into immobilised primers useful in amplifying a particular target nucleic acid sequence and/or in amplifying a complementary strand thereto.

G) Preparation of nucleic acid fragments

Apparatuses of the present invention can be used for various procedures some of which will be described later on. Nucleic acid fragments for use in colony generation may be prepared differently for the different procedures (referred to herein as "prepared nucleic acids"). Various preparation procedures are described below:

(i) Preparation of random DNA fragments

Here is described a method to prepare DNA originating from one biological sample (or from a plurality of samples) for amplification in the case where it is not necessary to keep track of the origin of the DNA when it is incorporated within a colony.

The DNA of interest is first extracted from the biological sample and cut randomly into "small" pieces (e.g., 50 to 10,000 bases long, but preferentially 500 to 1000 base pairs in length, represented by bar 'I', figure 13a). (This can be done e.g., by a phenol-chloroform extraction followed by ultrasound treatment, mechanical shearing, by partial digestion with frequent cutter restriction endonucleases or other methods known by those skilled in the art). In order to standardise experimental conditions, the extracted and cut DNA fragments can be size-fractionated, e.g., by agarose gel electrophoresis, sucrose gradient centrifugation or gel chromatography. Fragments obtained within a single fraction can be used in providing templates in order to reduce the variability in size of the templates.

Secondly, the extracted, cut and (optionally) sorted template DNA fragments can be ligated with oligonucleotide linkers (IIa and IIb, figure 13a) containing the sequence of the primer(s) which have previously been grafted onto a support. This can be achieved, for instance, using "blunt-end" ligation. Alternatively, the template

DNA fragments can be inserted into a biological vector at a site that is flanked by the sequence of the primers that are grafted on the support. This cloned DNA can be amplified within a biological host and extracted. Obviously, if one is working with a single primer grafted to the solid support for DNA colony formation, purifying fragments containing both P1 and P2 primers does not pose a problem. Hereafter, the DNA fragments obtained after such a suitable process are designated by the expression : "prepared genomic DNA" (III, figure 13a).

(ii) Preparation of random DNA fragments originating from a plurality of samples

Here it is described how to prepare DNA originating from a plurality of biological samples in the case where it is necessary to keep track of the origin of the DNA when it is incorporated within a colony.

The procedure is the same as that described in the previous section except that in this case, the oligonucleotide linkers used to tail the randomly cut genomic DNA fragments are now made of two parts; the sequence of the primers grafted onto the surface (P1 and P2, figure 13b) and a "tag" sequence which is different for each sample and which will be used for identifying the origin of the DNA colony. Note that for each sample, the tag may not be unique, but a plurality of tags could be used. Hereafter, we will designate the DNA fragments obtained after such a suitable process by the expression : "tagged genomic DNA" (III, Figure 13b).

This tagging procedure can be used for providing colonies carrying a means of identification which is independent from the sequence carried by the template itself. This could also be useful when some colonies are to be recovered specifically (using the procedure given in section D). This could also be useful in the case the recovered colonies are further processed, e.g., by creating new primary

colonies and a cross reference between the original colonies and the new colonies is desired.

(iii) Preparation of DNA fragments corresponding to a plurality of DNA sequences originating from one sample

The DNA of interest can first be extracted from a biological sample by any means known by those skilled in the art (as mentioned supra). Then the specific sequences of interest can be amplified with PCR, (step (i), figure 13c) using PCR primers (IIa and IIb) made of two parts; 1) at the 5'-end, the sequences corresponding to the sequences of primer oligonucleotide(s) that have been grafted onto a surface (P1 and P2) and 2) at the 3'-end, primer sequences specific to the sequence of interest (S1 and S2). Hereafter, we will designate the DNA fragments obtained after such a suitable process by the expression: "prepared DNA" (III, figure 13c).

(iv) Preparation of a plurality of DNA fragments originating from a plurality of samples

The procedure is the same as in the previous section except that in this case the DNA primers (IIa and IIb) used to perform the PCR amplification (step (i), figure 13d) are now made of three parts; 1) the sequence of the primers grafted onto the surface (P1 and P2), 2) a "tag" sequence which is different for each sample and which will be used for the identifying the origin of the DNA colony and 3) primer sequences surrounding the specific sequence of interest (S1 and S2). Note that for each sample, a plurality of tags might be used, as in (ii) supra.

Hereafter, we will designate the DNA fragments obtained after such a suitable process by the expression : "tagged DNA" (III, figure 13d). Potential uses of tags are the same as in (ii), supra.

(v) Preparation of mRNA

The procedure is similar to the procedures described for preparing DNA fragments in the previous sections except that the starting point is to extract mRNA by any means known to those skilled in the art (e.g., by use of commercially available mRNA preparation kits). The mRNA can be copied into double-stranded cDNA by any means known to those skilled in the art (e.g. by using a reverse transcriptase and a DNA polymerase). Certainly, the tags and primers described *supra* can be used in conjunction with the process of double-stranded cDNA synthesis to allow their incorporation into the templates. Hereafter, we will designate the mRNA fragments obtained after such suitable processes by the expressions: "prepared total mRNA" (cf. "prepared genomic DNA", as described in section (I) *supra*), "tagged total mRNA", (cf. "tagged genomic DNA", as described in section (ii) *supra*), "prepared mRNA" (cf. "prepared DNA", as described in section (iii) *supra*) and "tagged mRNA" (cf. "tagged DNA", as described in section (iv) *supra*).

H) Preferred Detection Assays

In assay procedures of the present invention labels may be used to provide detectable signals. Examples include:

- a) a fluorescent group or a energy-transfer based fluorescence system.
- b) a biotin based system. In this case colonies can be incubated with streptavidin labelled with a fluorescent group or an enzyme (e.g. fluorescent latex beads coated with streptavidin; streptavidin labelled with fluorescent groups; enzymes for use with the corresponding fluorescence assay).
- c) a system based on detecting an antigen or a fragment thereof - e.g. a hapten (including biotin and fluorescent groups). In this case colonies can be incubated with antibodies (e.g. specific for a hapten). The antibodies can be labelled with a fluorescent group or with an enzyme (e.g. fluorescent latex beads coated with the antibody; antibodies labelled with fluorescent groups; antibodies linked to an enzyme for use with a corresponding fluorescence or luminescence assay, etc.).
- d) a radio-label (e.g. incorporated by using a 5'-polynucleotide kinase and [γ - 32 P]adenosine triphosphate or a DNA polymerase and [α - 32 P or α - 33 P] deoxyribonucleoside triphosphates to add a radioactive phosphate group(s) to a nucleic acid). Here colonies can be incubated with a scintillation liquid.
- e) a dye or other staining agent.

Labels for use in the present invention are preferably attached

- a) to nucleic acids
 - b) to proteins which bind specifically to double stranded DNA (e.g., histones, repressors, enhancers)
- and/or
- c) to proteins which bind specifically to single stranded DNA (e.g. single-stranded nucleic acid binding protein).

Labelled colonies are preferably detected by:

- a) measuring fluorescence.
 - b) measuring luminescence.
 - c) measuring radioactivity
 - d) measuring flow or electric field induced fluorescence anisotropy.
- and/or
- e) measuring the polymer layer thickness.

Staining agents can be used in the present invention. Thus DNA colonies can be incubated with a suitable DNA-specific staining agent, such as the intercalating dyes, ethidium bromide, YO-YO, YO-PRO (Molecular Probes, Eugene, OR).

With certain staining agents the result can be observed with a suitable fluorescence imaging apparatus.

Examples of particular assays/procedures will now be described in greater detail:

663253 440460

I) Preferred Embodiments of Assays of the Present Invention

(i) Nucleic acid probe hybridisation assay

DNA colonies are first prepared for hybridisation. Then they are hybridised with a probe (labelled or unlabelled). If required, the hybridised probed is assayed, and the result is observed. This can be done with an apparatus of the present invention (e.g. as described *supra*).

Preparation for hybridisation

In a preferred embodiment of the present invention colonies are treated with a DNA restriction endonuclease which is specific either for a sequence provided by a double stranded form of one of the primers originally grafted onto the surface where colonies are formed or for another sequence present in a template DNA molecule (see e.g. figure 16c).

After restriction enzyme digestion, the colonies can be heated to a temperature high enough for double stranded DNA molecules to be separated. After this thermal denaturing step, the colonies can be washed to remove the non-hybridised, detached single-stranded DNA strands, leaving a remaining attached single-strand DNA.

In another embodiment the colonies can be partially digested with a double-strandspecific 3' to 5' DNA exonuclease (see section E, figure 10f) which removes one strand of DNA duplexes starting from the 3' end, thus leaving a part of a DNA molecule in single stranded form.

Alternatively, DNA in colonies can first be heat denatured and then partially digested with an single-strand specific 3' to 5' DNA exonuclease which digests single stranded DNA starting from the 3' end.

A further alternative is simply to heat denature DNA in the colonies.

Hybridisation of the probe

Single-stranded nucleic acid probes (labelled or unlabelled) can be hybridised to single-stranded DNA in colonies at the appropriate temperature and buffer conditions (which depends on the sequence of each probe, and can be determined using protocols known to those skilled in the art).

Assaying of unlabelled hybridised probes

A hybridised probe provided initially in unlabelled form can be used as a primer for the incorporation of the different (or a subset of the different) labelled (or a mix of labelled and unlabelled) deoxyribonucleoside triphosphates with a DNA polymerase. The incorporated labelled nucleotides can then be detected as described *supra*.

Cyclic assaying of labelled or unlabelled probes

Firstly, the DNA colonies can be prepared for hybridisation by the methods described *supra*. Then they can be hybridised with a probe (labelled or initially unlabelled). If required, hybridised labelled probes are assayed and the result is observed with an apparatus as described previously. The probe may then be removed by heat denaturing and a probe specific for a second DNA sequence may be hybridised and detected. These steps maybe repeated with new probes as many times as desired.

Secondly, the probes can be assayed as described *supra* for unlabelled probes, except that only a subset (preferably 1 only) of the different (labelled or unlabelled) nucleotides are used at each cycle. The colonies can then be assayed for monitoring the incorporation of the nucleotides. This second process can be repeated until a sequence of a desired length has been determined.

(ii) *in situ* RNA Synthesis assay

In this embodiment, DNA colonies can be used as templates for *in situ* RNA synthesis as depicted in figure 14. DNA colonies can be generated from templates and primers, such that a RNA polymerase promoter sequence is positioned at one end of the double-stranded DNA in the colony. DNA colonies can then be incubated with RNA polymerase and the newly synthesised RNA (cRNA) can be assayed as desired. The detection can be done non-specifically (e.g., staining) or in a sequence dependent way (e.g., hybridisation).

The DNA template (I, figure 14a) to be amplified into a colony is generated by PCR reaction using primers (IIa and IIb) which have the following four parts; 1) sequence identical to the sequences of the primers grafted onto the surface ('P1' and 'P2'), 2) a "tag" sequence which is different for each sample, a sequence corresponding to a RNA polymerase promoter, ie. the T3, T7 and SP6 RNA promoters, ('RPP', figure 14a) and 4) primer sequences surrounding the specific sequence of interest ('S1' and 'S2'). Hereafter, we will designate the DNA fragments obtained after such a suitable process by the expression: "tagged RNA synthesis DNA" (III, figure 14b).

After amplification of the DNA template from the original DNA sample, these templates are used to generate DNA colonies. The DNA colonies (IV, figure 14c) are then incubated with the RNA polymerase specific for the RNA polymerase promoter ('RPP', figure 14c). This will generate a copy of RNA specific for the DNA colony template (Template-cRNA, V, figure 14d).

cRNA thus synthesised can be isolated and used as hybridisation probes, as messenger RNA (mRNA) templates for *in vitro* protein synthesis or as templates for *in situ* RNA sequence analysis.

(iii) Methods for sequencing

In another embodiment of the present invention, colonies can be analysed in order to determine sequences of nucleic acid molecules which form the colonies. Since very large numbers of the same nucleic acid molecules can be provided within each colony the reliability of the sequencing data obtained is likely to be very high.

The sequences determined may be full or partial. Sequences can be determined for nucleic acids present in one or more colonies. A plurality of sequences may be determined at the same time.

In some embodiments the sequence of a complementary strand to a nucleic acid strand to be sequenced (or of a part thereof) may be obtained initially. However this sequence can be converted using base-pairing rules to provide the desired sequence (or a part thereof). This conversion can be done via a computer or via a person. It can be done after each step of primer extension or can be done at a later stage.

Sequencing can be done by various methods. For example methods relying on sequential restriction endonuclease digestion and linker ligation can be used. One such method is disclosed in WO95/27080 for example. This method comprises the steps of: ligating a probe to an end of a polynucleotide, the probe having a nuclease recognition site; identifying one or more nucleotides at the end of the polynucleotide; and cleaving the polynucleotide with a nuclease recognising the nuclease recognition site of the probe such that the polynucleotide is shortened by one or more nucleotides.

However in a preferred method of the present invention, amplified nucleic acid molecules (preferably in the form of colonies, as disclosed herein) are sequenced by allowing primers to hybridise with the nucleic acid molecules, extending the primers and detecting the nucleotides used in primer extension. Preferably, after extending a primer by a single nucleotide, the nucleotide is detected before a

further nucleotide is used in primer extension (step-by-step sequencing).

One or more of the nucleotides used in primer extension may be labelled. The use of labelled nucleotides during primer extension facilitates detection. (The term "label" is used in its broad sense to indicate any moiety that can be identified using an appropriate detection system. Preferably the label is not present in naturally-occurring nucleotides.) Ideally, labels are non-radioactive, such as fluorophores. However radioactive labels can be used.

Where nucleotides are provided in labelled form the labels may be the same for different nucleotides. If the same label is used each nucleotide incorporation can be used to provide a cumulative increase of the same signal (e.g. of a signal detected at a particular wavelength). Alternatively different labels may be used for each type of nucleotide (which may be detected at different wavelengths).

Thus four different labels may be provided for dATP, dTTP, dCTP and dGTP, or the same label may be provided for them all. Similarly, four different labels may be provided for ATP, UTP, CTP and GTP, or the same label may be provided for them all). In some embodiments of the present invention a mixture of labelled and unlabelled nucleotides may be provided, as will be described in greater detail later on.

In a preferred embodiment of the present invention the sequencing of nucleic acid molecules present in at least 2 different colonies is performed simultaneously. More preferably, sequencing of nucleic acid molecules present in over 10, over 100, over 1000 or even over 1,000,000 different colonies is performed simultaneously. Thus if colonies having different nucleic acids molecules are provided, many different sequences (full or partial) can be determined simultaneously - i.e. over 10, over 100, over 1000 or even over 1,000,000 different sequences may be determined simultaneously.

If desired, controls may be provided, whereby a plurality of colonies comprising the same nucleic acid molecules are provided. By

determining whether or not the same sequences are obtained for nucleic acid molecules in these colonies it can be ascertained whether or not the sequencing procedure is reliable.

One sequencing method of the present invention is illustrated in figure 17, which is entitled "*in situ* sequencing". On prepared DNA colonies hybridised with an appropriate sequencing primer, cyclic addition of the individual deoxyribonucleoside triphosphates and DNA polymerase will allow the determination of the DNA sequence immediately 3' to the sequencing primer. In the example outlined in figure 17, the addition of dGTP allows the determination of colony 1 to contain a 'G'. In the second cycle addition of dATP is detected in both colonies, determining that both colonies have an 'A' in the next position. After several repetitions of the addition of single deoxyribonucleoside triphosphates, it will be possible to determine any sequence. For example sequences of at least 10, at least 20, at least 50 or at least 100 bases may be determined.

If colonies are provided initially in a form comprising double-stranded molecules the colonies can be processed to provide single-stranded molecules for use in sequencing as described above. (It should however be noted that double stranded molecules can be used for sequencing without such processing. For example a double stranded DNA molecule can be provided with a promoter sequence and step-by-step sequencing can then be performed using an RNA polymerase and labelled ribonucleotides (cf Figure 16 d)). Another alternative is for a nick to be introduced in a double stranded DNA molecule so that nick translation can be performed using labelled deoxyribonucleotides. and a DNA polymerase with 5' to 3' exonuclease activity.)

One way of processing double-stranded molecules present in colonies to provide single-stranded colonies as described later with reference to Figure 19. Here double-stranded immobilised molecules present in a colony (which may be in the form of bridge-like structures) are

cleaved and this is followed by a denaturing step. (Alternatively a denaturing step could be used initially and could be followed by a cleavage step). Preferably cleavage is carried out enzymatically. However other means of cleavage are possible, such as chemical cleavage. (An appropriate cleavage site can be provided in said molecule). Denaturing can be performed by any suitable means. For example it may be performed by heating and / or by changing the ionic strength of a medium in the vicinity of the nucleic acid molecules.

Once single-stranded molecules to be sequenced are provided, suitable primers for primer extension can be hybridised thereto. Oligonucleotides are preferred as primers. These are nucleic acid molecules that are typically 6 to 60, e.g. 15 to 25 nucleotides long. They may comprise naturally and / or non-naturally occurring nucleotides. (However other molecules, e.g. longer nucleic acid strands may alternatively be used as primers, if desired.) The primers for use in sequencing preferably hybridise to the same sequences present in amplified nucleic acid molecules as do primers that were used to provide said amplified nucleic acids. (Primers having the same / similar sequences can be used for both amplification and sequencing purposes).

When primers are provided in solution and are annealed (hybridised) to nucleic acid molecules present in colonies to be sequenced, those primers which remain in solution or which do not anneal specifically can be removed after annealing. Preferred annealing conditions (temperature and buffer composition) prevent non-specific hybridisation. These may be stringent conditions. Such conditions would typically be annealing temperatures close to a primer's T_m (melting temperature) at a given salt concentration (e.g. 50 mM primer in 200 mM NaCl buffer at 55°C for a 20-mer oligonucleotide with 50% GC content). (Stringent conditions for a given system can be determined by a skilled person. They will depend on the base composition, GC content, the length of the primer used and the salt concentration. For a 20 base oligonucleotide of 50% GC, calculated average annealing temperature is 55-60°C, but in practice may vary between 35 to 70°C).

Primers used for primer extension need not be provided in solution, since they can be provided in immobilised form. In this embodiment the primers should be provided in the vicinity of the immobilised molecules to which they are to be annealed. (Such primers may indeed already be present as excess immobilised primers that were not used in amplifying nucleic acid molecules during the formation of colonies.)

The nucleic acid molecules present in colonies to be sequenced will include a sequence that hybridises to the primers to be used in sequencing (preferably under "stringent" conditions). This portion can be added to a given molecule prior to amplification (which molecule may have a totally / partially unknown sequence) using techniques known to those skilled in the art. For example it can be synthesised artificially and can be added to a given molecule using a ligase.

Once a nucleic acid molecule annealed to a primer is provided, primer extension can be performed. RNA or DNA polymerases can be used. DNA polymerases are however the enzymes of choice for preferred embodiments. Several of these are commercially available. Polymerases which lack 3' to 5' exonuclease activity can be used, such as T7 DNA polymerase or the small (Klenow) fragment of DNA polymerase I may be used [e.g. the modified T7 DNA polymerase Sequenase™ 2.0 (Amersham) or Klenow fragment (3' to 5' exo-, New England Biolabs)]. However it is not essential to use such polymerases. Indeed, where it is desired that the polymerases have proof-reading activity polymerases lacking 3' to 5' exonuclease activity would not be used. Certain applications may require the use of thermostable polymerases such as ThermoSequenase™ (Amersham) or Taquenase™ (ScienTech, St Louis, MO). Any nucleotides may be used for primer extension reactions (whether naturally occurring or non-naturally occurring). Preferred nucleotides are deoxyribonucleotides; dATP, dTTP, dGTP and dCTP (although for some applications the dTTP analogue dUTP is preferred) or ribonucleotides ATP, UTP, GTP and CTP; at least some of which are provided in labelled form.

A washing step is preferably incorporated after each primer extension step in order to remove unincorporated nucleotides that may interfere with subsequent steps. The preferred washing solution should be compatible with polymerase activity and have a salt concentration that does not interfere with the annealing of primer molecules to the nucleic acid molecules to be sequenced. (In less preferred embodiments, the washing solution may interfere with polymerase activity. Here the washing solution would need to be removed before further primer extension.)

Considering that many copies of molecules to be sequenced can be provided in a given colony, a combination of labelled and non-labelled nucleotides can be used. In this case, even if a small proportion of the nucleotides are labelled (e.g. fluorescence-labelled), the number of labels incorporated in each colony during primer extension can be sufficient to be detected by a detection device. For example the ratio of labelled to non-labelled nucleotides may be chosen so that, on average, labelled nucleotides are used in primer extension less than 50%, less than 20%, less than 10% or even less than 1% of the time (i.e. on average in a given primer extension step a nucleotide is incorporated in labelled form in less than 50%, less than 20%, less than 10%, or less than 1% of the extended primers.)

Thus in a further embodiment of the present invention there is provided a method for sequencing nucleic acid molecules present in a colony of the present invention, the method comprising the steps of:

- a) providing at least one colony comprising a plurality of single stranded nucleic acid molecules that have the same sequences as one another and that are hybridised to primers in a manner to allow primer extension in the presence of nucleotides and a nucleic acid polymerase;
- b) providing said at least one colony with a nucleic acid polymerase and a given nucleotide in labelled and unlabelled form under conditions that allow extension of the primers if a complementary base or if a plurality of such bases is present

at the appropriate position in the single stranded nucleic acid molecules present in said at least one colony;

- c) detecting whether or not said labelled nucleotide has been used for primer extension by determining whether or not the label present on said nucleotide has been incorporated into extended primers;

Steps b) and c) may be repeated one or more times. Preferably a plurality of different colonies are provided and several different sequences are determined simultaneously.

This further embodiment of the present invention can be used to reduce costs, since relatively few labelled nucleotides are needed. It can also be used to reduce quenching effects.

It is however also possible to use only labelled nucleotides for primer extension or to use a major portion thereof (eg. over 50 %, over 70% or over 90% of the nucleotides used may be labelled). This can be done for example if labels are selected so as to prevent or reduce quenching effects. Alternatively labels may be removed or neutralised at various stages should quenching effects become problematic (e.g. laser bleaching of fluorophores may be performed). However this can increase the number of steps required and it is therefore preferred that labels are not removed (or at least that they are not removed after each nucleotide has been incorporated but are only removed periodically). In other less preferred embodiments, the primer itself and its extension product may be removed and replaced with another primer. If required, several steps of sequential label-free nucleotide additions may be performed before actual sequencing in the presence of labelled nucleotides is resumed. A further alternative is to use a different type of label from that used initially (e.g. by switching from fluorescein to rhodamine) should quenching effects become problematic.

In preferred embodiments of the present invention a plurality of labelled bases are incorporated into an extended primer during sequencing. This is advantageous in that it can speed up the sequencing procedure relative to methods in which, once a labelled

base has been incorporated into an extended primer, the label must be removed before a further labelled base can be incorporated. (The plurality of labelled bases may be in the form of one or more contiguous stretches, although this is not essential.)

The present invention therefore also includes within its scope a method for sequencing nucleic acid molecules, comprising the steps of:

- a) using a first colony to provide a plurality of single stranded nucleic acid molecules that have the same sequences as one another and that are hybridised to primers in a manner to allow primer extension in the presence of nucleotides and a nucleic acid polymerase;
- b) using a second colony to provide a plurality of single stranded nucleic acid molecules that have the same sequences as one another, and that are also hybridised to primers in a manner to allow primer extension in the presence of nucleotides and a nucleic acid polymerase;
- c) providing each colony with a nucleic acid polymerase and a given labelled nucleotide under conditions that allow extension of the primers if a complementary base or if a plurality of such bases is present at the appropriate position in the single stranded nucleic acid molecules;
- d) detecting whether or not said labelled nucleotide has been used for primer extension at each colony by determining whether or not the label present on said nucleotide has been incorporated into extended primers;
- e) repeating steps c) and d) one or more times so that extended primers comprising a plurality of labels are provided.

Preferably the sequences of the nucleic acid molecules present at said first and said locations are different from one another - i.e. a plurality of colonies comprising different nucleic acid molecules are sequenced

In view of the foregoing description it will be appreciated that a large number of different sequencing methods using colonies of the present invention can be used. Various detection systems can be used to detect labels used in sequencing in these methods (although in certain embodiments detection may be possible simply by eye, so that no detection system is needed). A preferred detection system for fluorescent labels is a Charge-Coupled-Device (CCD) camera, which can optionally be coupled to a magnifying device. Any other device allowing detection and, preferably, also quantification of fluorescence on a surface may be used. Devices such as fluorescent imagers or confocal microscopes may be chosen.

In less preferred embodiments, the labels may be radioactive and a radioactivity detection device would then be required. Ideally such devices would be real-time radioactivity imaging systems. Also less preferred are other devices relying on phosphor screens (Molecular Dynamics) or autoradiography films for detection.

Depending on the number of colonies to be monitored, a scanning system may be preferred for data collection. (Although an alternative is to provide a plurality of detectors to enable all colonies to be covered.) Such a system allows a detector to move relative to a plurality of colonies to be analysed. This is useful when all the colonies providing signals are not within the field of view of a detector. The detector may be maintained in a fixed position and colonies to be analysed may be moved into the field of view of the detector (e.g. by means of a movable platform). Alternatively the colonies may be maintained in fixed position and the detection device may be moved to bring them into its field of view.

The detection system is preferably used in combination with an analysis system in order to determine the number (and preferably also the nature) of bases incorporated by primer extension at each colony after each step. This analysis may be performed immediately after each step or later on, using recorded data. The sequence of nucleic

acid molecules present within a given colony can then be deduced from the number and type of nucleotides added after each step.

Preferably the detection system is part of an apparatus comprising other components. The present invention includes an apparatus comprising a plurality of labelled nucleotides, a nucleic acid polymerase and detection means for detecting labelled nucleotides when incorporated into a nucleic acid molecule by primer extension, the detection means being adapted to distinguish between signals provided by labelled nucleotides incorporated at different colonies.

The apparatus may also include temperature control, solvent delivery and washing means. It may be automated.

Methods and apparatuses within the scope of the present invention can be used in the sequencing of:

- unidentified nucleic acid molecules (i.e. *de novo* sequencing);
- and nucleic acid molecules which are to be sequenced to check if one or more differences relative to a known sequence are present (e.g. identification of polymorphisms). This is sometimes referred to as "re-sequencing".

Both *de novo* sequencing and re-sequencing are discussed in greater detail later on (see the following sections (v) and (vi)).

For *de novo* sequencing applications, the order of nucleotides applied to a given location can be chosen as desired. For example one may choose the sequential addition of nucleotides dATP, dTTP, dGTP, dCTP; dATP, dTTP, dGTP, dCTP; and so on. (Generally a single order of four nucleotides would be repeated, although this is not essential.) For re-sequencing applications, the order of nucleotides to be added at each step is preferably chosen according to a known sequence.

Re-sequencing may be of particular interest for the analysis of a large number of similar template molecules in order to detect and identify sequence differences (e.g. for the analysis of recombinant plasmids in candidate clones after site directed mutagenesis or more importantly, for polymorphism screening in a population). Differences

from a given sequence can be detected by the lack of incorporation of one or more nucleotides present in the given sequence at particular stages of primer extension. In contrast to most commonly used techniques, the present method allows for detection of any type of mutation such as point mutations, insertions or deletions. Furthermore, not only known existing mutations, but also previously unidentified mutations can be characterised by the provision of sequence information.

In some embodiments of the present invention long nucleic acid molecules may have to be sequenced by several sequencing reactions, each one allowing for determination of part of the complete sequence. These reactions may be carried out at different colonies (where the different colonies are each provided with the same nucleic acid molecules to be sequenced but different primers), or in successive cycles applied at the same colony (where between each cycles the primers and extension products are washed off and replaced by different primers).

(iv) DNA Fingerprinting

This embodiment of the present invention aims to solve the problem of screening a large population for the identification of given features of given genes, such as the detection of single nucleotide polymorphisms.

In one preferred embodiment, it consists in generating tagged genomic DNA (see section G(ii) *supra*). (Thus each sample originating from a given individual sample has been labelled with a unique tag). This tagged DNA can be used for generating primary colonies on an appropriate surface comprising immobilised primers. Several successive probe hybridisation assays to the colonies can then be performed. Between each assay the preceding probe can be removed, e.g. by thermal denaturation and washing.

Advantages of this embodiment of the present invention over other approaches for solving this problem are illustrated in the following example of a potential practical application.

It is intended to detect which part of a gene (of, e.g., 2000 bases in size), if any, is related to a disease phenotype in a population of typically 1,000 to 10,000 individuals. For each individual, a PCR amplification can be performed to specifically amplify the gene of interest and to link a tag and a colony generating primer (refer to section G(iv), preparation of "tagged DNA").

In order to obtain a representative array of sample, one might want to array randomly 500,000 colonies (i.e. 10 times redundancy, so to have only a small probability of missing the detection of a sample). With a colony density of 10,000 colonies per mm^2 , a surface of $\sim 7 \text{ mm} \times 7 \text{ mm}$ can be used. This is a much smaller surface than any other technology available at present time (e.g. The HySeq approach uses $220 \text{ mm} \times 220 \text{ mm}$ for the same number of samples (50,000) without redundancy). The amount of reactants (a great part of the cost) will be proportional to the surface occupied by of the array of samples. Thus the present invention can provide an 800 fold improvement over the presently available technology.

Using an apparatus to monitor the result of the 'in situ' sequencing or probe hybridisation assays, it should take on the order of 1 to 10 seconds to image a fluorescent signal from colonies assayed using fluorescence present on a surface of $\sim 1 \text{ mm}^2$. Thus, assuming that the bottleneck of the method is the time required to image the result of the assay, it takes of the order of 10 minutes to image the result of an assay on 50,000 samples (500,000 colonies). To provide 200 assays including imaging (on one or several $7 \text{ mm} \times 7 \text{ mm}$ surfaces), using the present invention can take less than 36 hours. This represents a 20 times improvement compared to the best method known at present time (HySeq claims 30 days to achieve a comparable task).

Improvements (colony densities 10 times higher and imaging time of 1 second) could allow for much higher throughput and finally the ultimately expected throughput could be about 2000 times faster than the best, not yet fully demonstrated, technology available at present time.

Another advantage of using the present invention lies in the fact that it overcomes the problem arising with individuals who have heterozygous mutations for a given gene. While this problem may be addressed by existing sequencing methods to determine allelic polymorphisms, current high throughput mutation detection methods based on oligonucleotide probe hybridisation may lead to difficulties in the interpretation of results due to an unequal hybridisation of probes in cases of allelic polymorphisms and therefore errors can occur. In this embodiment of the present invention, each colony arises from a single copy of an amplified gene of interest. If an average of 10 colonies are generated for each individual locus, there will be an average of 5 colonies corresponding to one version of a gene and 5 colonies corresponding to the other version of the gene. Thus heterozygotic mutations can be scored by the number of times a single allele is detected per individual genome sample.

(v) DNA resequencing

This embodiment of the present invention provides a solution to the problem of identifying and characterising novel allelic polymorphisms within known genes in a large population of biological samples.

In its preferred embodiment it consists in obtaining tagged DNA (each sample originating from a given individual has been tagged with a unique tag - see section G(iv)). This encoded DNA can then be used for generating primary colonies on an appropriate surface comprising immobilised primers. Several successive assays of probe hybridisation to the colonies can then be performed wherein between each cyclic assay the preceding probe can be removed by thermal denaturation and washing. Preferably, the DNA sequence 3' to a

specific probe may be determined directly by 'in situ sequencing' (section I(iii), Methods of sequencing).

The advantages of the present invention over other approaches for solving this problem are illustrated in the following example of potential practical application:

It is desired to identify the variability of the sequence of a gene (of, e.g., 2 000 bases in size), if any, in a population of typically 4 000 individuals. It is assumed that a reference sequence of the gene is known. For each individual, a PCR amplification can be performed to specifically amplify the gene of interest and link a tag and a colony generating primer. In order to obtain a representative array of sample, one might want to array randomly 40 000 colonies (i.e. 10 times redundancy, so to have a small probability of missing the detection of a sample). With a colony density of 10 000 colonies per mm², a surface of ~2 mm x 2 mm can be used.

Using an apparatus with a CCD camera (having a 2000 x 2000 pixel chip) to monitor the result of the assay, it should take of the order of 10 seconds to image a fluorescent signal from colonies on a surface of 4 mm². If it is assumed possible to read at least 20 bases during one round of the assay, this requires 61 imaging steps (3n+1 imaging steps are necessary for reading n numbers of bases). If it is assumed that the bottleneck of the method is the time to image the result of the assay, it takes of the order of 15 minutes to image the result of an assay on 4 000 samples (40 000 colonies). To realise 100 assays (on one or several 2x2mm² surfaces) in order to cover the entire gene of interest, the present invention can allow the whole screening experiment to be performed in approximately one day, with one apparatus. This can be compared to the most powerful systems operational at the present time.

In this embodiment of the present invention with conservative assumptions (colony density, imaging time, size of the CCD chip), a throughput of 3.2x 10⁶ bases per hour could be reached, i.e. a 400

fold improvement when compared to the most commonly used system at present time (current DNA sequencers have a typical throughput of the order of 8,000 bases read/hour).

(vi) *de novo* DNA sequencing

This embodiment of the present invention aims to solve the problem of sequencing novel genomes (or parts thereof) with low cost and in short time, where the sequence of the DNA is not known. Genomic DNA can be prepared, either directly from the total DNA of an organism of interest or from a vector into which DNA has been inserted. The prepared genomic DNA (from whatever source) can be used to generate DNA colonies. The DNA colonies can then be digested with a rare-cutting restriction enzyme, whose site is included in the linker, denatured and sequenced.

Figure 16 depicts an example of *de novo* DNA sequencing. In this example, genomic DNA is fragmented into pieces of 100 to 2000 base pairs (see preparation of random DNA fragments, section G(i)). These fragments will be ligated to oligonucleotide linkers (IIa and IIb, figure 16a) which include sequences specific for the grafted primers on the surface ('P1' and 'P2'), a sequence which is recognised by a rare-cutting restriction nuclease ('RE') and a sequence corresponding to a sequencing primer ('SP'), resulting in templates (III, figure 16b). Using this prepared DNA as template for DNA colony formation, one obtains primary colonies (IV, figure 16c). These colonies are then digested with the corresponding restriction endonuclease and denatured to remove the non-attached DNA strand (V, figure 16d). The sequencing primer (SP) is then annealed to the attached single-stranded template (figure 16e). Incorporation and detection of labelled nucleotides can then be carried out as previously described (see section I(iii), Methods of Sequencing).

In this embodiment, the throughput obtainable can be at least 400 times higher than presently available methods.

(vii) mRNA gene expression monitoring

This embodiment of our invention means to solve the problem of monitoring the expression of a large number of genes simultaneously.

Its preferred embodiment is depicted in figure 17.

Firstly, primary colonies are prepared, as depicted in figure 3. In its preferred form, the DNA used for this preparation is 'prepared genomic DNA' or 'tagged genomic DNA', as described in section G(i) and G(iii), respectively, and where the DNA is either from the whole genome of one (or several) organism(s) or from a subset thereof (e.g., from a library of previously isolated genes). In figure 17, the uppercase letters, "A", "B" and "D" represent colonies which have arisen from genes which exhibit high, medium and low expression levels, respectively, and "E" represents colonies arising from non-expressed genes (in real cases, all these situations may not necessarily be present simultaneously).

Secondly, the colonies are treated to turn them into supports (i.e. secondary primers) for secondary colony growing (step i in figure 17a), as described in section E. At this stage (figure 17b), the treated colonies are represented by underlined characters (A, B, D, or E).

Thirdly, (step ii in figure 17b) this support for secondary colony growing is used to regenerate colonies from mRNA (or cDNA) templates extracted from a biological sample, as described in section C. If the template is mRNA, the priming step of colony regeneration will be performed with a reverse transcriptase. After a given number of colony amplification cycles, preferably 1 to 50, the situation will be as depicted in (figure 17c): the colonies corresponding to highly expressed genes (represented by the letter "A") are totally

regenerated, as their regeneration has been initiated by many copies of the mRNA; the colonies corresponding to genes of medium expression levels (represented by the letters "b" and "B"), have been only partially regenerated; only a few of the colonies corresponding to rare genes (represented by the letter "d"), have been partially regenerated; the colonies corresponding to non-expressed sequences (represented by the letter "E"), have not been regenerated at all.

Lastly, (step iii in figure 17c), additional cycles of colony growing are performed (preferably 2 to 50), and the colonies which have not been totally regenerated during the previous steps finally become totally regenerated, "b" becomes "B", "d" becomes "D" (figure 17d) : the colonies corresponding to genes with high and medium expression levels are all regenerated "A" and "B" or "B"; the colonies corresponding to genes with low levels of expression are not all regenerated "D" and "D"; the colonies corresponding to non-expressed sequences are not regenerated at all "E".

The relative levels of expression of the genes can be obtained by the following preferred methods:

- Firstly levels of expression can be monitored by following the rate of regeneration of the colonies (i.e., by measuring the amount of DNA inside a colony after different number of colony growing cycles during step (iii)) as the rate at which a colony is regenerated will be linked the number of mRNA (or cDNA) molecules which initiated the regeneration of that colony (at first approximation, the number of DNA molecules after n cycles, noted M(n), in a colony undergoing regeneration should be given by $M(n) = M_0 r^{(n-1)}$, where M_0 is the number of molecules which initiated the regeneration of the colony, r is the growing rate and n is the number of cycles);

- Secondly, levels of expression can be monitored by counting, for each gene, the number of colonies which have been regenerated and comparing this number to the total number of colonies corresponding to that gene. These measurements will generally give access to the

relative expression levels of the genes represented by the colonies. The identification of the colonies is preferably performed by fingerprinting, in a manner essentially similar to embodiment, section I(iv). Note that encoding the DNA samples is not required, but can be considered as an alternative to the direct identification of the DNA in the colonies. This can be of practical interest because with coding, the same codes (thus the same oligonucleotides involved in assaying the code) can be used for any set of genes, whereas without code, a different set of specific oligonucleotides has to be used for each set of genes.

This embodiment of our invention has many advantages if compared to current state of the art including: a very high throughput; no requirement for prior amplification of the mRNA (even though prior amplification is compatible with or invention); small amounts of samples and reactants are required due to the high density of samples with our invention; the presence of highly expressed genes has no incidence on the ability to monitor genes with low levels of expression; the ability to simultaneously monitor low and high levels of expression within the set of genes of interest.

When the initial DNA in the generation of the primary DNA colony is made from the DNA of a whole genome, this embodiment also provides the following features: there is no interference between genes expressed at high level and at low level even though one has not performed specific amplification of the genes of interest. This is a unique feature of the use of this invention: specific amplification is not possible because the initial assumption of this embodiment is to monitor the expression genes which may have not yet been isolated, thus which are unknown, and thus for which no specific (unique) sequences are known and which specific sequences would have been necessary for specific gene amplification. The ability of our invention to perform this type of mRNA expression monitoring is due to the fact that when the primary colonies are prepared, statistically, each piece of the initial genome will be represented by the same number of colonies. Thus, frequent and rare DNA will initiate the same number of colonies (e.g., one colony per added

genome molecule). Quantitative information might be obtained both from frequent and rare mRNAs by monitoring the growing rate of the colonies.

(viii) Isolation and characterisation of novel expressed genes

This embodiment of our invention means to solve the problem of isolating the genes which are specifically induced under given conditions, e.g., in specific tissues, different strains of a given species or under specific activation. A practical example is the identification of genes which are up or down regulated after drug administration.

The preferred embodiment for isolating genes from a specific or activated biological sample (hereafter called target sample) which are up-regulated compared with a reference biological sample (hereafter called reference sample) is depicted in figure 18.

Firstly, primary colonies are prepared (figure 18a). In its preferred form, the DNA used for this preparation is prepared genomic DNA or tagged genomic DNA, as described in sections G(i) and G(ii), respectively, where the DNA is either from the whole genome of one (or several) organism(s) or from a subset thereof (e.g., from a library of previously isolated genes), and where both the primers used for colony generation (hereafter called P1 and P2) contain a endonuclease restriction site. In figure 18a, "A" represents colonies which have arisen from genes expressed in both the reference sample and the target sample, "B" represents colonies which have arisen from genes expressed only in the reference sample, "C" represents colonies which have arisen from genes expressed only in the target sample, and "D" represents colonies arising from non-expressed genes (in real cases, all these situations may not necessarily be present simultaneously).

Secondly, primary colonies are then treated to generate secondary primers as the support for secondary colony growing (step i in figure 18a). At this stage (b), the colonies are represented as underlined characters (A, B, C, D).

Thirdly, (step ii in figure 21b) the secondary primers are used to regenerate colonies using mRNA or cDNA (represented by "mA + mB") extracted from the biological reference sample as a template, as described in G(v). If the template is mRNA, the first elongation step of colony regeneration will be performed with a reverse transcriptase. After enough colony growing cycles, preferably 5 to 100, only the colonies corresponding to genes expressed in the reference sample ("A" and "B") will be regenerated, as depicted in (figure 18c).

In step (iii), the colonies are digested with a restriction enzyme (represented by RE) which recognises a site in the flanking primer sequences, P1 and P2, which are grafted on the support and which were the basis of primary colony generation. Importantly, only the colonies which have been regenerated during step (ii) will be digested. This is because the support for secondary colony growth is made of single stranded DNA molecules, which can not be digested by the restriction enzyme. Only the regenerated colonies are present in a double stranded form, and are digested. After digestion, the situation is the one depicted in figure 18d. The colonies corresponding to the genes expressed in the reference sample have totally disappeared, i.e., they are not even present as a support for secondary colony growth, and the colonies corresponding to genes expressed only in the target sample "C" and the colonies corresponding to non-expressed genes "D" are still present as a support for secondary colony generation.

In step (iv), mRNA (or cDNA) (represented by "mA + mC") extracted from the target sample is used to generate secondary colonies. Because colonies corresponding to mA and mB no longer exist, only the colonies corresponding to mC can be regenerated (ie. Only the mRNA

specifically expressed in the target sample). After sufficient number of colony growing cycles (preferably 5 to 100), the situation is such that only the colonies corresponding to genes expressed specifically in the target sample are regenerated ("C", figure 18e).

In step (v), the regenerated colonies "C" are used to generate copies of the DNA that they contain by performing several (preferably 1 to 20) colony growing cycles in the presence of the primers P1 and P2, as described in section D of the present invention. A PCR amplification is then performed using P1 and P2 in solution (described in section D) and the amplified DNA characterised by classical methods.

The preferred embodiment for isolating genes from a specific or activated biological sample which are less expressed than in a reference biological sample is depicted in figure 19. The different steps involved in this procedure are very similar to those involved in the isolation of gene which are more regulated than in the reference sample, and the notation are the same as in figure 18. The only difference is to inverse the order used to regenerate the colonies: in step (ii), the mRNA used is the one extracted from the target biological sample ("mA + mC") instead of the mRNA extracted from the reference biological sample ("mA + mB"), and in step (iv), the mRNA used is the one extracted from the reference biological sample ("mA + mB") instead of the one extracted from the target sample ("mA + mC"). As a result, only the DNA from colonies corresponding to genes which are expressed in the reference sample but not in the target sample is recovered and amplified ("B", figure 19f).

Claims

1. A method of nucleic acid amplification, comprising the steps of:
 - A. providing a plurality of primers that are immobilised but that have one end exposed to allow primer extension;
 - B. allowing a single stranded target nucleic acid molecule to anneal to one of said plurality of primers over part of the length of said single stranded nucleic acid molecule and then extending that primer using the annealed single stranded nucleic acid molecule as a template, so as to provide an extended immobilised nucleic acid strand;
 - C. separating the target nucleic molecule from the extended immobilised nucleic acid strand;
 - D. allowing the extended immobilised nucleic acid strand to anneal to one of said plurality of primers referred to in step A) and then extending that primer using the extended immobilised nucleic acid strand as a template, so as to provide another extended immobilised nucleic acid strand; and optionally,
 - E. separating the annealed extended immobilised nucleic acid strands from one another.

2. A method according to claim 1, further comprising:
 - F. using at least one extended immobilised nucleic acid strand to repeat steps D) and E), so as to provide additional extended immobilised nucleic acid strands and, optionally,
 - G. repeating step F) one or more times.

3. A method according to claim 1 or claim 2, wherein said single-stranded target nucleic acid is produced by providing a given nucleic acid sequence to be amplified (which sequence may be known or unknown) and adding thereto a first nucleic acid sequence and a second nucleic acid sequence; wherein said first nucleic acid sequence hybridises to one of said plurality of primers and said second nucleic acid sequence is complementary to a sequence which hybridises to one of said plurality of primers.

4. A method according to any preceding claim; wherein said single-stranded target nucleic acid is produced by providing a given nucleic acid sequence to be amplified (which sequence may be known or unknown) and adding thereto a first nucleic acid sequence and a second nucleic acid sequence; wherein said first nucleic acid sequence hybridises to one of said plurality of primers and said second nucleic acid sequence is the same as the sequence of one of said plurality of primers.

5. A method according to claim 3 or claim 4 wherein said first and second nucleic acid sequences are provided at first and second ends of said single-stranded target nucleic acid.

6. A method according to any of claims 3 to 5, wherein a tag is also added to the given nucleic acid sequence, said tag enabling amplification products of the given nucleic acid sequence to be identified.

7. A method according to any preceding claim wherein the plurality of primers is a plurality of primers that have the same sequence.

8. A method according to any of claims 1 to 6, wherein the plurality of primers comprises at least two different types of primer, one type having a different sequence from another type.

9. A method according to claim 8, wherein the plurality of primers consists of 2^n different types of primer; wherein n is an integer.

10. A method according to claim 9, where n is 2.

11. A method according to any of claims 8 to 10, wherein the different types of primer are present in substantially the same concentrations as one another

12. A method according to any preceding claim, wherein the primers are substantially homogeneously dispersed over a given area

13. A method according to any preceding claim, wherein the primers are located in a predetermined arrangement (e.g. in a grid pattern)

14. A method according to any preceding claim, wherein a supply of nucleotides and a nucleic acid polymerase are used to extend primers

15. A method according to any preceding claim, wherein heating is used to separate annealed nucleic acid strands

16. A method according to claim 15 when dependent upon claim 14, wherein the nucleic acid polymerase is not rendered inactive by the heating conditions used to separate annealed nucleic acid strands.

17. A method according to claim 16, wherein said nucleic acid polymerase is taq polymerase, is another polymerase that is derivable from a thermophilic organism; or is a thermostable derivative thereof.

18. A method according to any preceding claim, wherein said primer extension results in the incorporation of one or more detectable labels (e.g. fluorescent labels or radiolabels) into extended immobilised nucleic acid strands.

19. A method according to any preceding claim, further including the step of treating one or more extended immobilised nucleic acid strands so as to release a nucleic acid molecule or a part thereof.

20. A method according to claim 19, wherein said treating consists of cleavage with a restriction endonuclease or with a ribozyme.

21. A method according to any preceding claim, wherein one or more of said primers has a restriction endonuclease recognition site or a ribozyme recognition site or has part of such a site, which part becomes complete when primer extension occurs.

22. A method according to any preceding claim that is automated to allow repeated cycles of nucleic acid amplification.

23. A method according to any preceding claim, when used to amplify a plurality of different nucleic acid sequences

24. A method according to claim 23, when used to amplify a plurality of different nucleic acid sequences simultaneously.

25. A method according to claim 23 or 24, wherein said different nucleic acid sequences are each provided with a first and second nucleic acid sequence as described in any of claims 3 to 5, said first and second nucleic acid sequences being the same for the each of the different nucleic acid sequences.

26. A method according to any of claims 23 to 25, wherein said different nucleic acid sequences are each provided with a different tag so that the different sequences can be distinguished from one another.

27. A plurality of immobilised nucleic acids producible by a method according to any preceding claim.

28. A plurality of immobilised nucleic acids in the form of one or more distinct areas on a surface, each area comprising a plurality of identical nucleic acid strands and a plurality of identical complementary strands thereto; wherein each nucleic acid strand within such an area is located so that another nucleic acid strand is located on the surface within a distance of the length of that strand.

29. A plurality of immobilised nucleic acids according to claim 27 or claim 28, wherein there is at least one distinct area present per mm^2 of surface on which the nucleic acids are immobilised.

30. A plurality of immobilised nucleic acids according to claim 28, wherein the number of distinct areas/ mm^2 of surface on which the nucleic acids are immobilised is greater than 1, greater than 10^2 , greater than 10^3 or greater than 10^4 .

31. The use of a method according to any of claims 1 to 26 or of a

plurality of immobilised nucleic acid molecules according to any of claims 27 to 30 in providing nucleic acid molecules for sequencing.

32. The use according to claim 31, wherein sequencing is performed by extending primers hybridised to single stranded nucleic acid molecules and detecting the nucleotides used in primer extension.

33. The use according to claim 32, wherein sequencing is performed in a step-by-step manner, whereby after extending a primer by a single nucleotide, the nucleotide is detected before a further nucleotide is used in primer extension.

34. The use according to claim 32 or 33, wherein said primers hybridise to the same sequences as the primers used in the method of claim 1 to provide the immobilised nucleic acid molecules for sequencing.

35. The use according to claim 32 or 33, wherein said primers have the same sequences as the primers used in the method of claim 1 to provide the immobilised nucleic acid molecules for sequencing.

36. The use according to claim 31, wherein nicks are provided in double-stranded nucleic acid molecules, nick translation is performed and the nucleotides used in nick translation are detected.

37. The use according to claim 31, wherein an RNA polymerase is used to synthesise an RNA strand from a DNA molecule and the nucleotides used to produce said RNA strand are detected.

38. The use according to any of claims 32 to 37, wherein all or at least some of said nucleotides are labelled nucleotides.

39. The use according to claim 38, wherein said labelled nucleotides all have the same label.

40. The use according to claim 38 or claim 39, wherein said labelled nucleotides are fluorescence labelled

41. The use according to any of claims 38 to 40, wherein a mixture of labelled and non-labelled nucleotides are used.
42. The use according to claim 41, wherein the labelled nucleotides comprise less than 50 % of the nucleotides used.
43. The use according to claim 42, wherein the labelled nucleotides comprise less than 10 % of the nucleotides used.
44. The use according to any of claims 31 to 43, wherein the sequencing is parallel sequencing of nucleic acid molecules present in at least 2 different distinct areas.
45. The use according to any of claims 31 to 43, wherein the sequencing is parallel sequencing of nucleic acid molecules present in over 10 different distinct areas.
46. The use according to any of claims 31 to 43, wherein the sequencing is parallel sequencing of nucleic acid molecules present in over 100 different distinct areas.
47. The use according to any of claims 31 to 43, wherein the sequencing is parallel sequencing of nucleic acid molecules present in over 1000 different distinct areas.
48. The use according to any of claims 31 to 43, wherein the sequencing is parallel sequencing of nucleic acid molecules present in over 1000000 different distinct areas.
49. The use according to any of claims 31 to 43, wherein a plurality of different sequences are determined in parallel.
50. The use of a method according to any of claims 1 to 26 or of a plurality of immobilised nucleic acid molecules according to any of claims 27 to 30 in providing amplified nucleic acid molecules for diagnosis.

51. The use of a method according to any of claims 1 to 26 or of a plurality of immobilised nucleic acid molecules according to any of claims 27 to 30 in providing amplified nucleic acid molecules for screening.

52. The use of a method according to any of claims 1 to 26 or of a plurality of immobilised nucleic acid molecules according to any of claims 27 to 30 in providing amplified nucleic acid molecules to be used as a support for other components.

53. The use of a method according to any of claims 1 to 26 or of a plurality of immobilised nucleic acid molecules according to any of claims 27 to 30 in generating additional nucleic acid molecules in free (rather than immobilised) form.

54. The use of a method according to claim 53 in *in situ* RNA synthesis

55. The use of a method according to any of claims 1 to 26 or of a plurality of immobilised nucleic acid molecules according to any of claims 27 to 30 in monitoring gene expression

56. The use of a method according to any of claims 1 to 26 or of a plurality of immobilised nucleic acid molecules according to any of claims 27 to 30 in identifying nucleic acid molecules with gene products that are rarely expressed.

57. The use of a method according to any of claims 1 to 26 or of a plurality of immobilised nucleic acid molecules according to any of claims 27 to 30 in identifying heterozygous individuals

58. The use of a method according to any of claims 1 to 26 or of a plurality of immobilised nucleic acid molecules according to any of claims 27 to 30 in nucleic acid fingerprinting

59. An apparatus for performing a method as described in any of claims 1 to 26; comprising a plurality of immobilised primers, a

nucleic acid polymerase, a plurality of nucleotides and means for separating annealed nucleic acid strands.

60. An apparatus according to claim 59, wherein the means for separating annealed nucleic acid strands comprises a controlled heating means.

61. An apparatus for analysing a plurality of nucleic acid molecules according to any of claims 27 to 30, wherein said apparatus comprises a source of reactants and detector means for detecting one or more signals produced after said reactants have been applied to said nucleic acid molecules.

62. An apparatus according to claim 61 wherein said detector means has sufficient resolution to distinguish between the distinct areas referred to in claim 28.

63. An apparatus according to claim 61 or claim 62 comprising a charge coupled device (CCD).

64. An apparatus according to claim 63 wherein said charge coupled device (CCD) is operatively connected with a magnifying device (e.g. a microscope).

65. A kit for use in screening, diagnosis or in nucleic acid sequencing; comprising a plurality of immobilised nucleic acid according to any of claims 27 to 30.

66. The invention substantially as hereinbefore described.

WO 98/44151

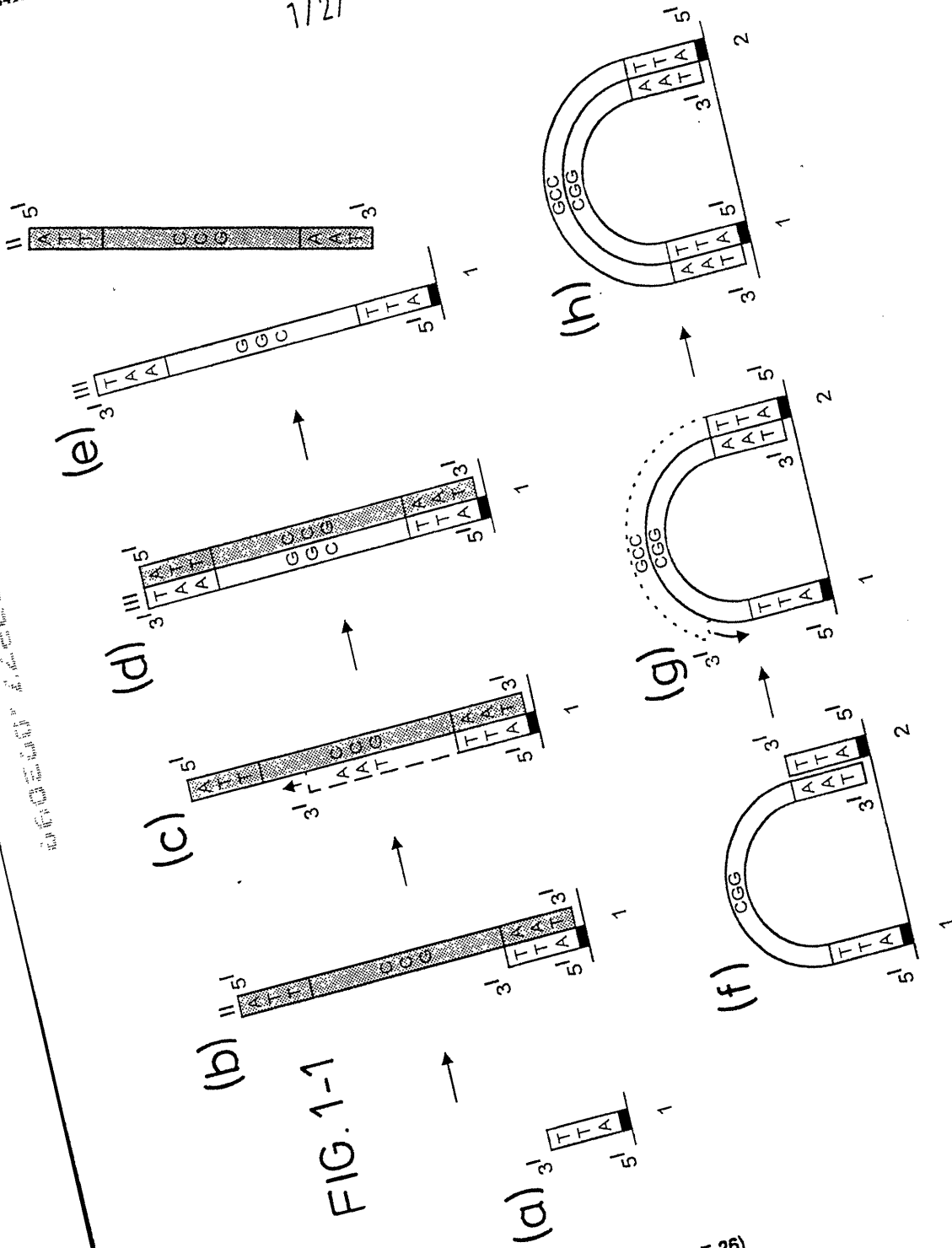
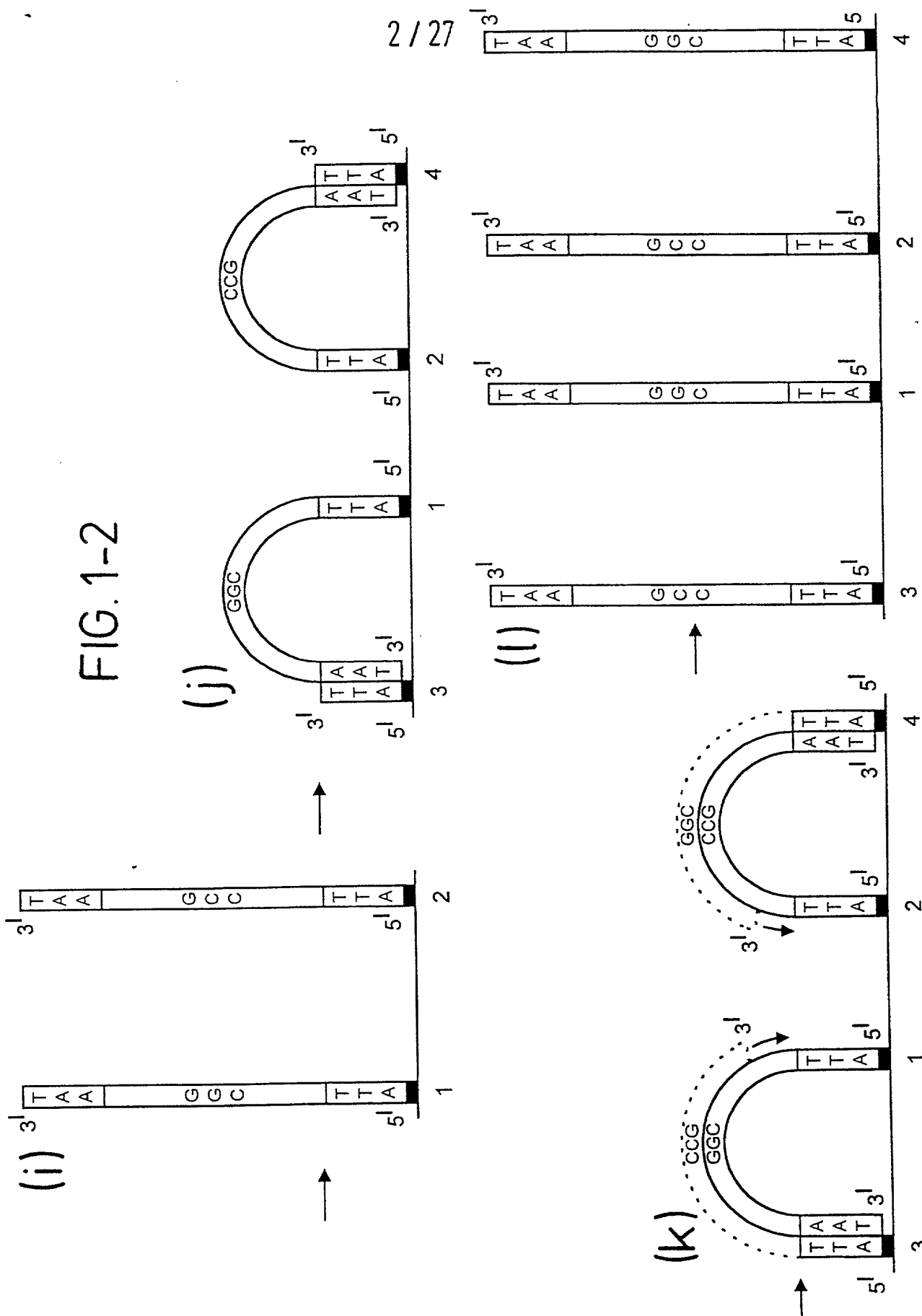

FIG. 1-1

SUBSTITUTE SHEET (RULE 26)

66660 433460



2/27

FIG. 1-2

3/27

660660 222060

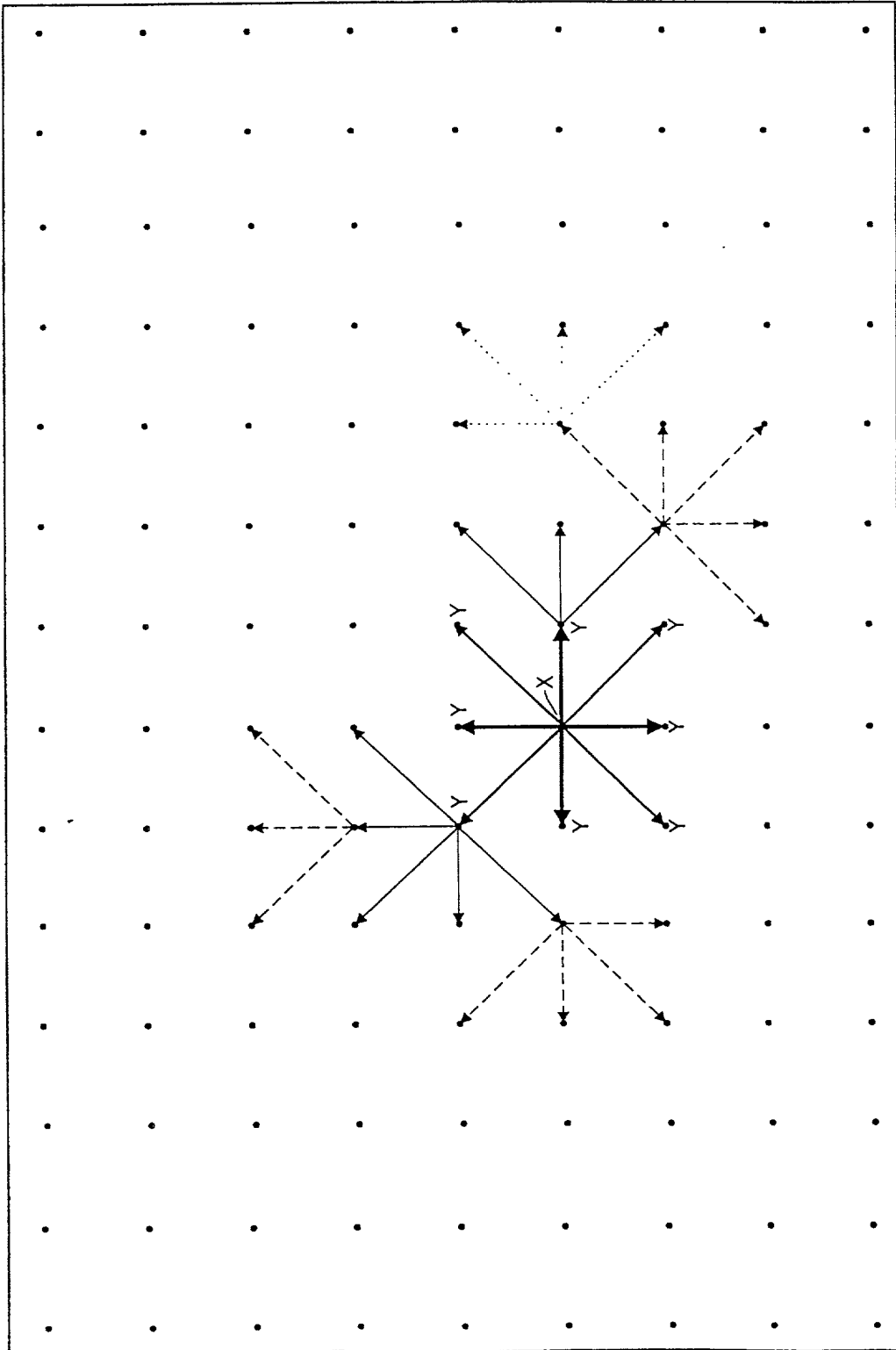
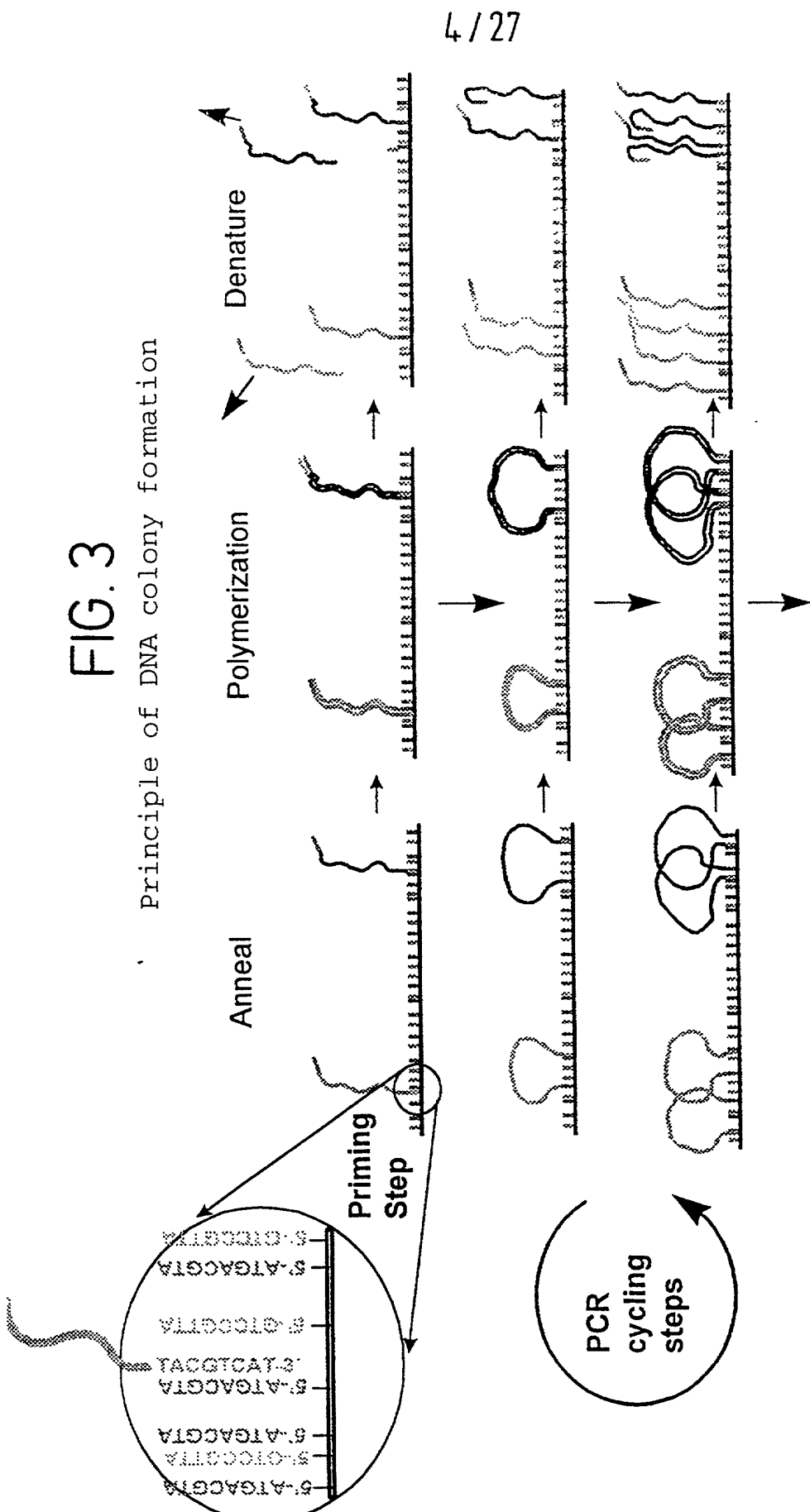

FIG. 2 SHOWS SCHEMATIC VIEW OF COLONY GROWTH



Characteristics of DNA Colonies

- 1) Each colony is composed of identical copies (10,000 to 100,000) of the original DNA template
- 2) Colonies are 0.1 - 5 mm in size and are spaced between 5 - 50 mm apart
- 3) $\sim 10^6 - 10^7$ individual colonies / cm²

5/27

FIG. 4a

Colony generation on tubes functionalised with oligonucleotide p57 (control). Results of visualisation of fluorescent microspheres. Hybridisation with probe detects 0.10 fmol/tube.

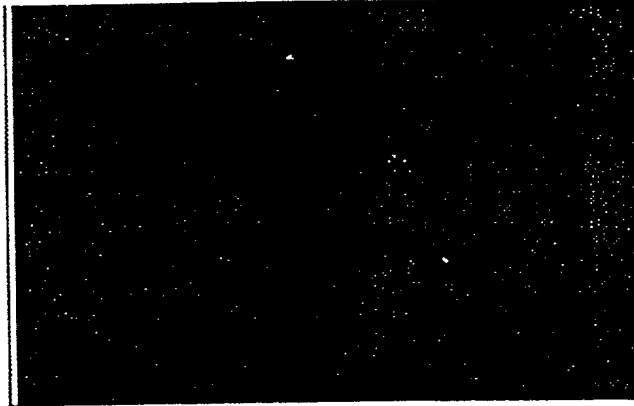
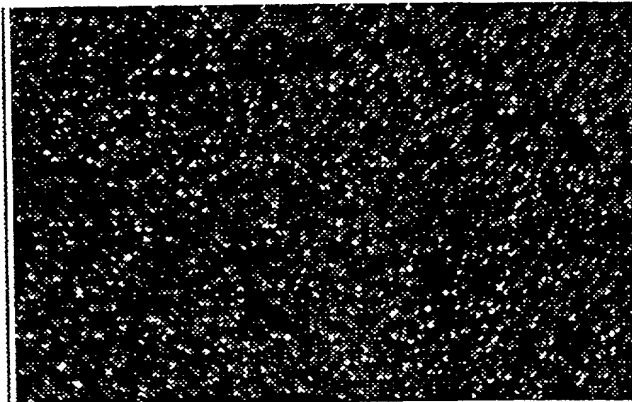

FIG. 4b

Colony generation on tubes functionalised with oligonucleotide p58. Results of visualisation of fluorescent microspheres. Hybridisation with probe detects 6.2 fmol/tube



5,600,000

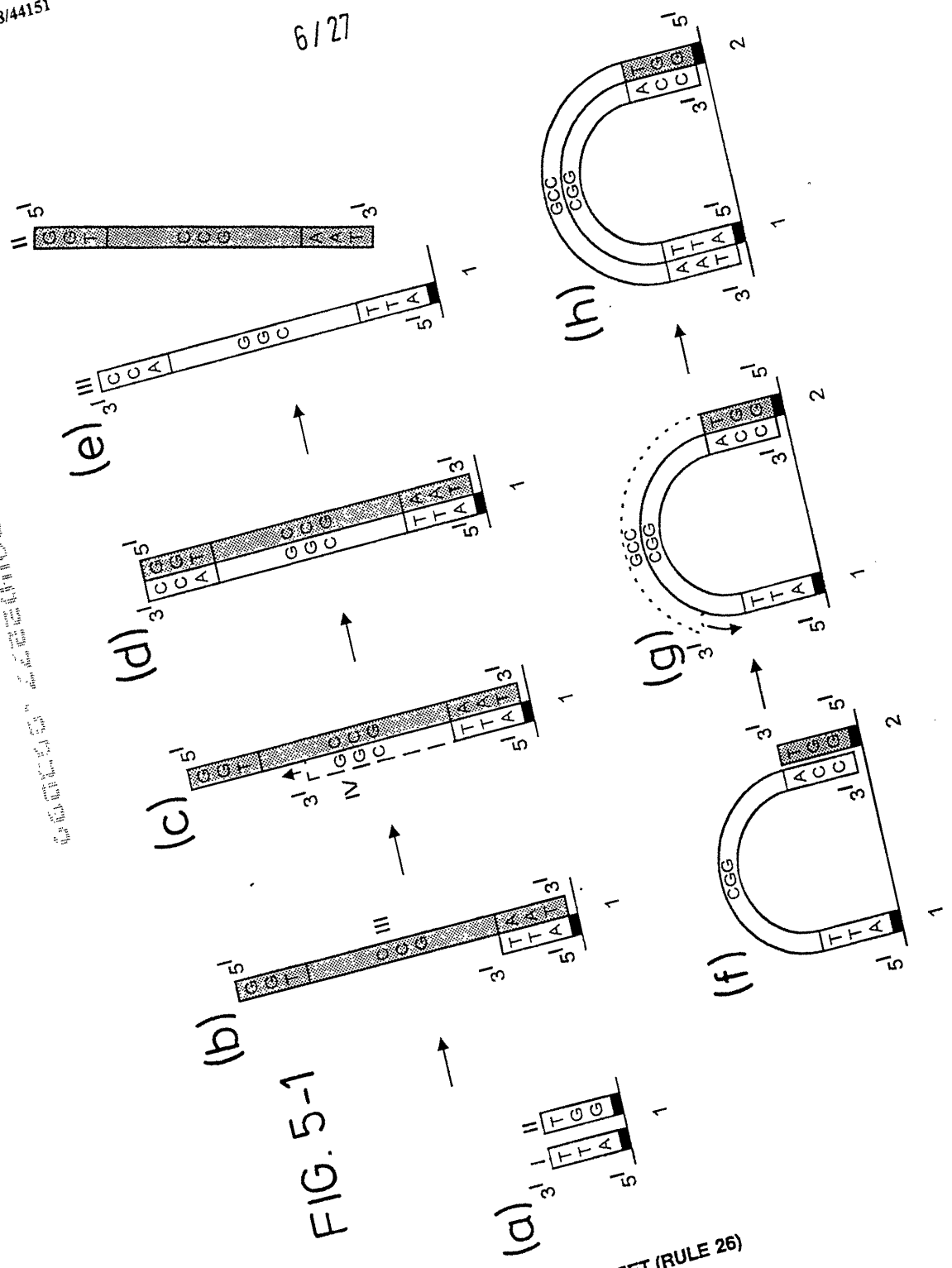
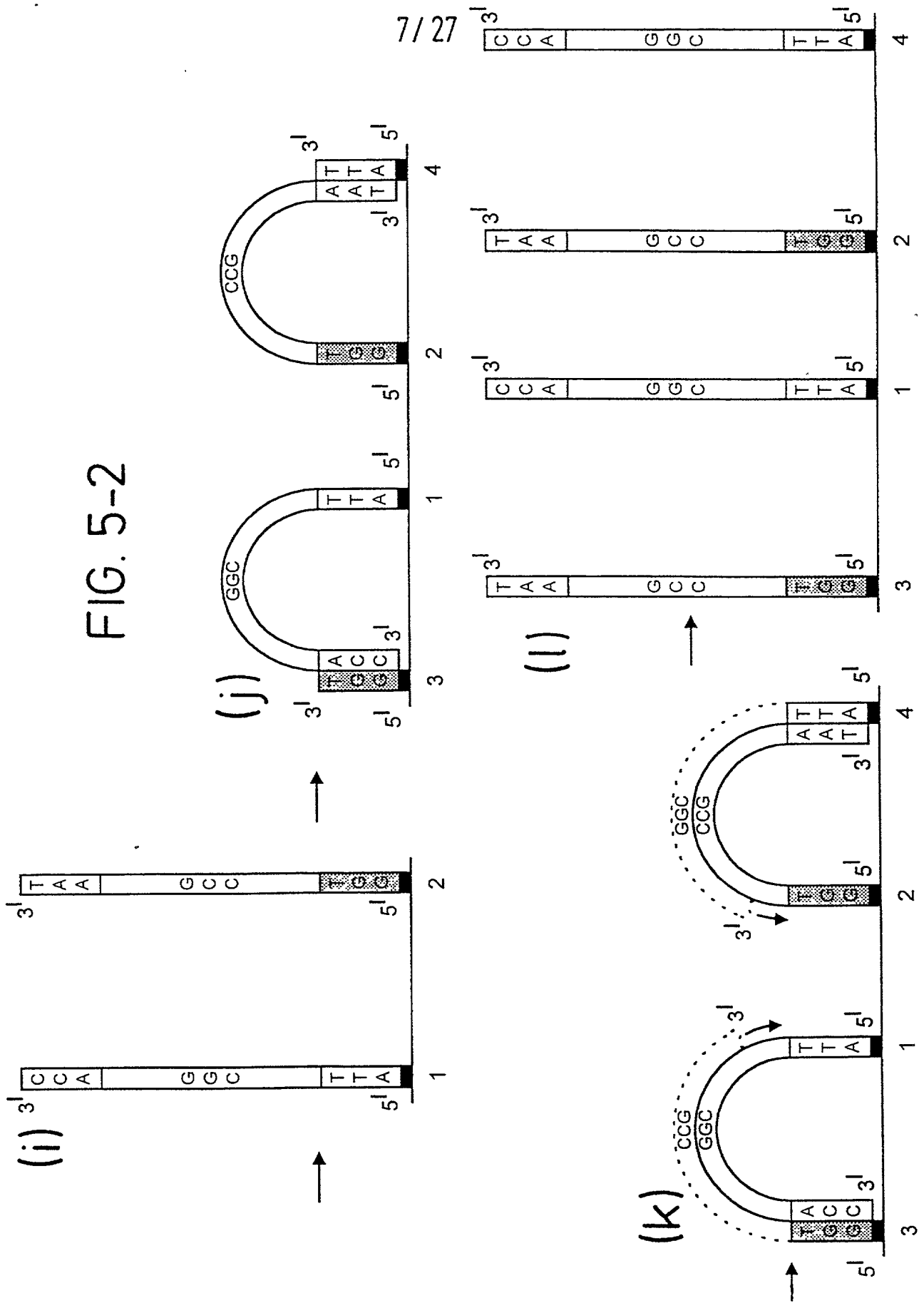

FIG. 5-1

SUBSTITUTE SHEET (RULE 26)



7/27

8/27

FIG. 6(a)

DNA amplification - detection of colonies with DNA intercalating dyes

i) control



ii) with template

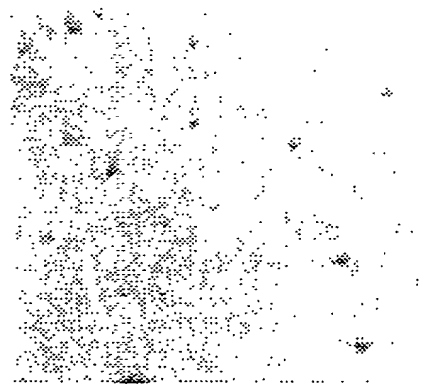
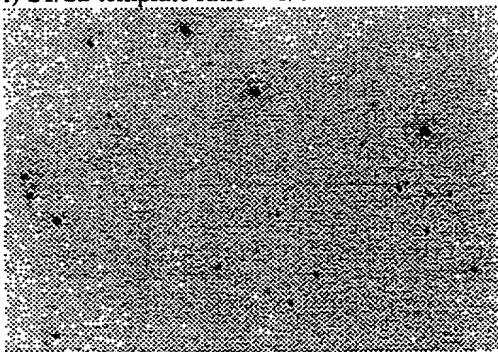

FIG. 6(b)

DNA amplification: detection of colonies by specific probe hybridisation

i) S1/S2 template ratio = 1/0



ii) S1/S2 template ratio = 1/10

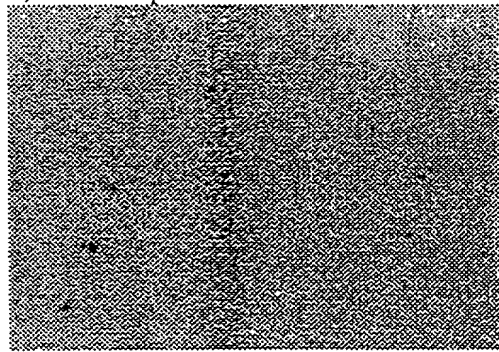

iii) S1/S2 template ratio = 0/1

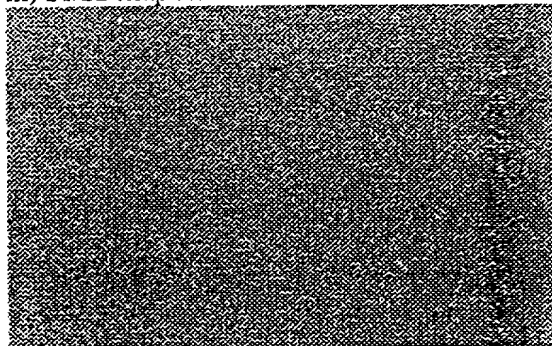

660660 4422460

66550 222110

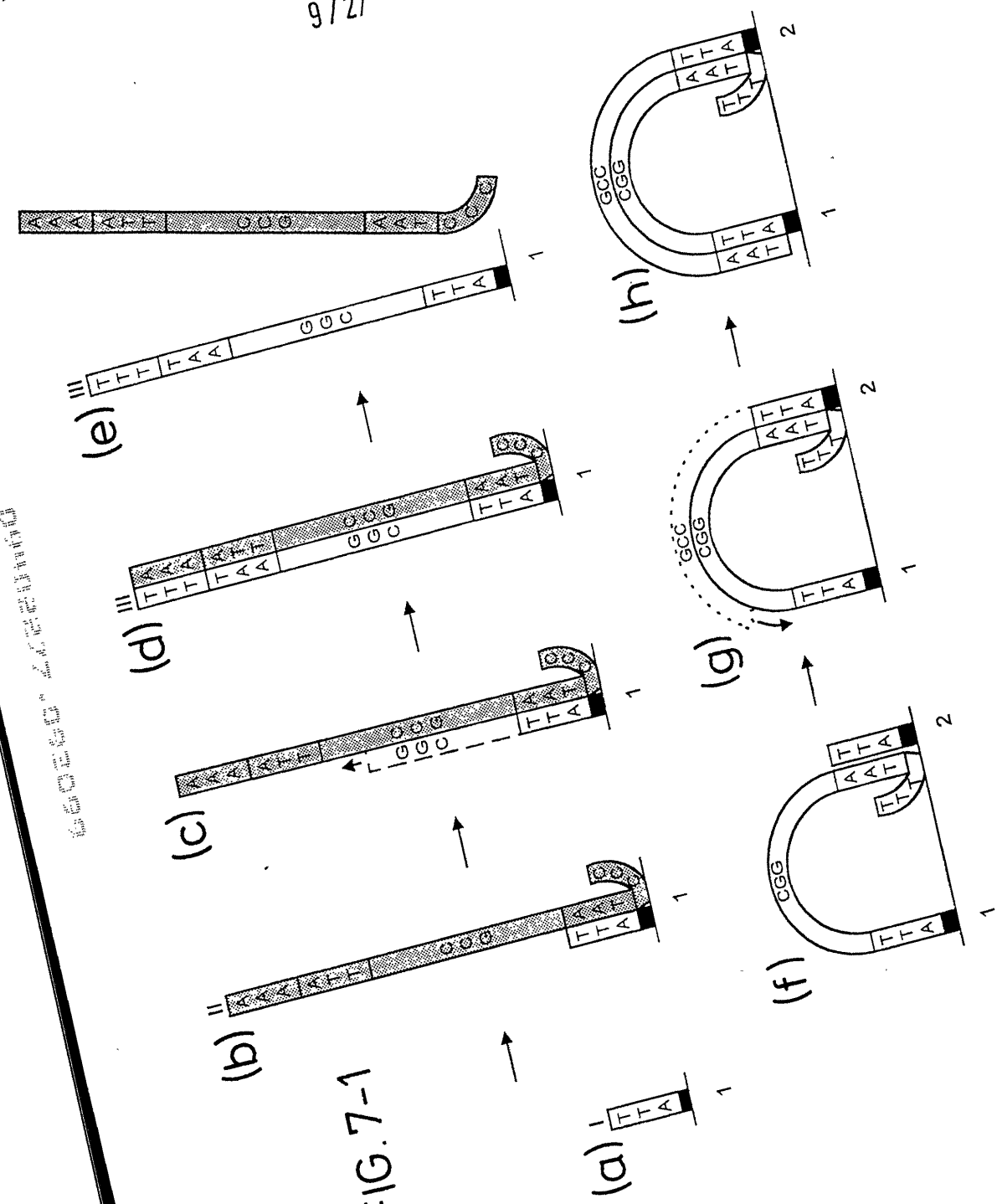
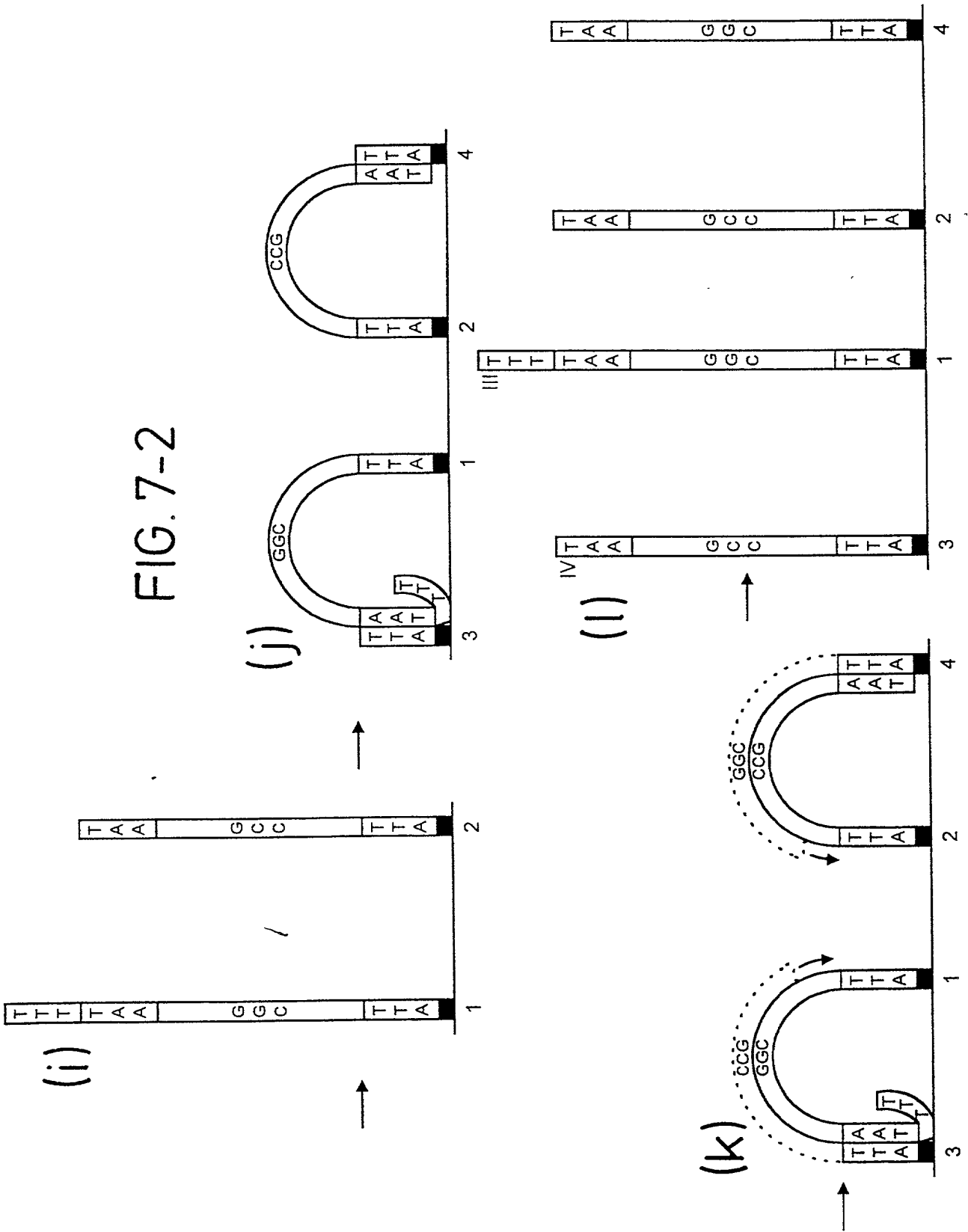

FIG. 7-1

10/27

66660423060

FIG. 7-2



11/27

FIG. 8-1

(a)

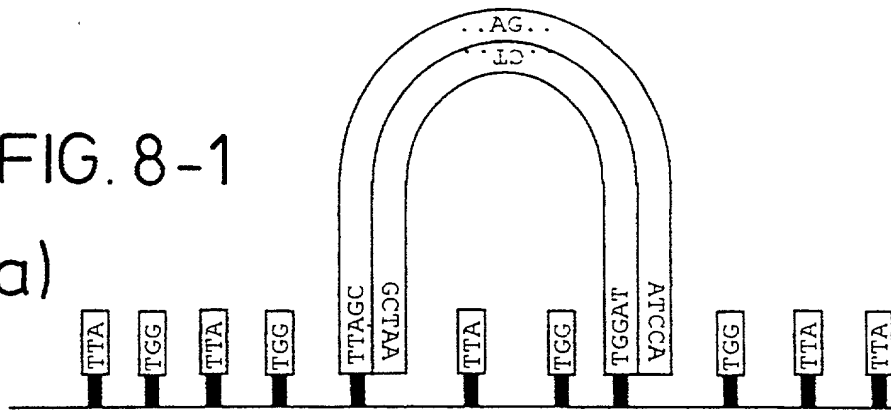

(i)

(b)

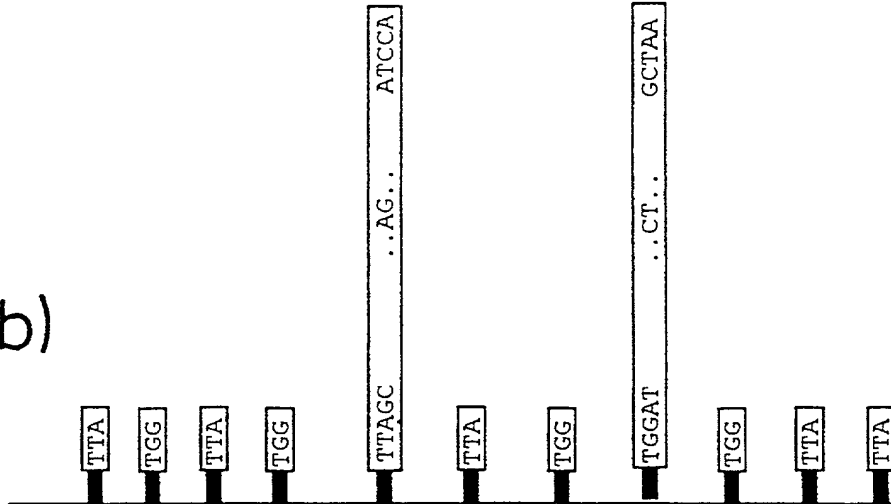

(ii)

(c)

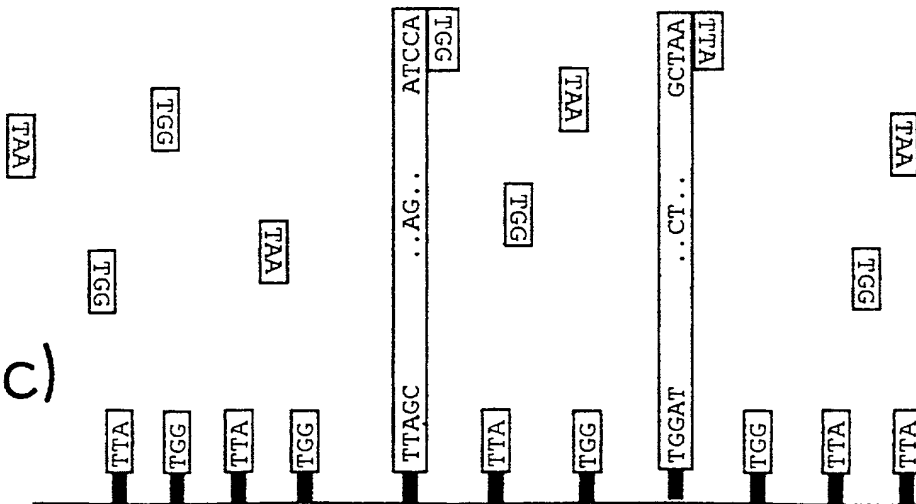

66666 4420440

12 / 27

(iii)

FIG. 8-2

(d)

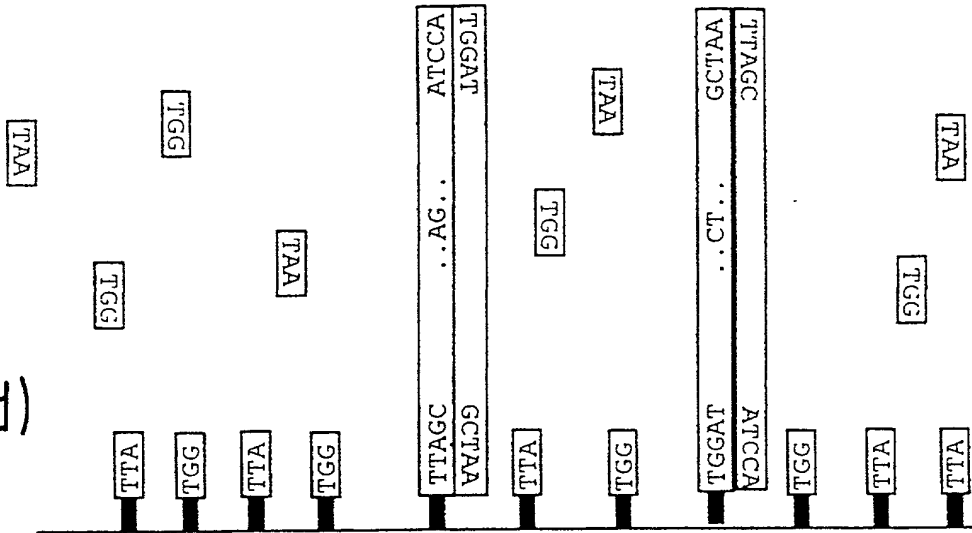

(iv)

TGGAT	..CT..	GCTAA
TTAGC	..AG..	ATCCA

TGGAT	..CT..	GCTAA
TTAGC	..AG..	ATCCA

(e)

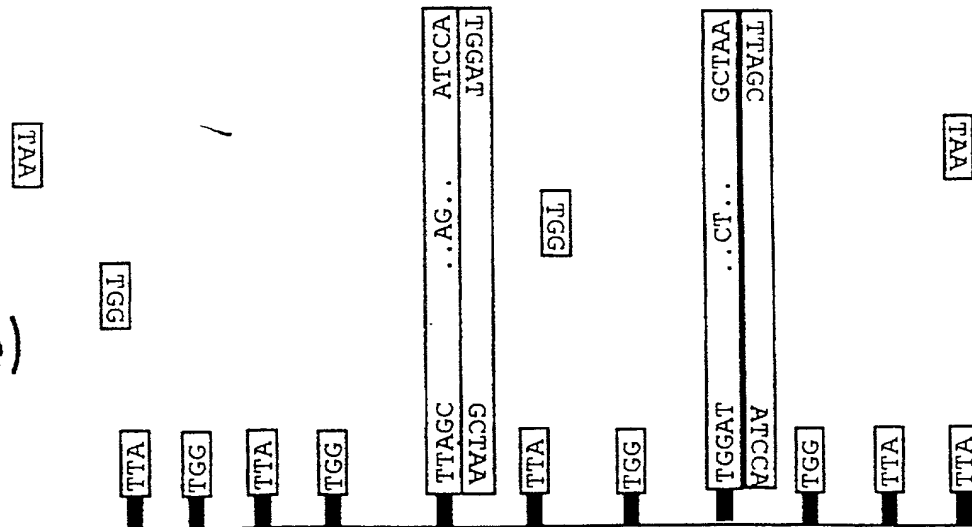
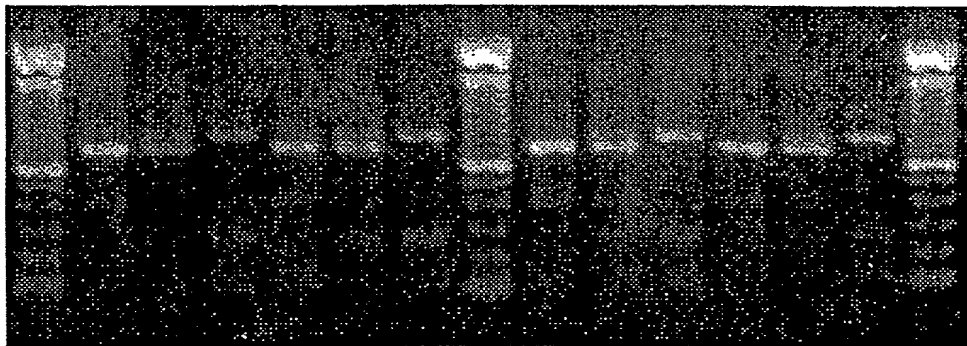

FIG. 9

A)



std. A1 A1,2 A2 B1 B1,2 B2 std C1 C1,2 C2 D1 D1,2 D2 std

B)

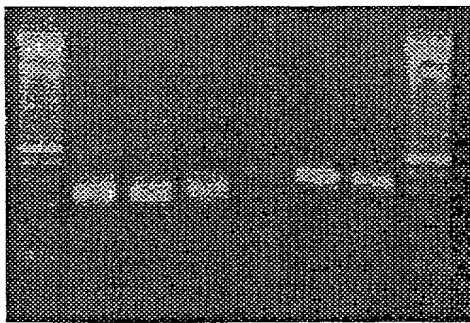

std. E1 E1,2 E2 F1 F1,2 F2 std

660660 4420160

14 / 27

FIG. 10-1
(a)

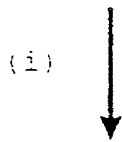
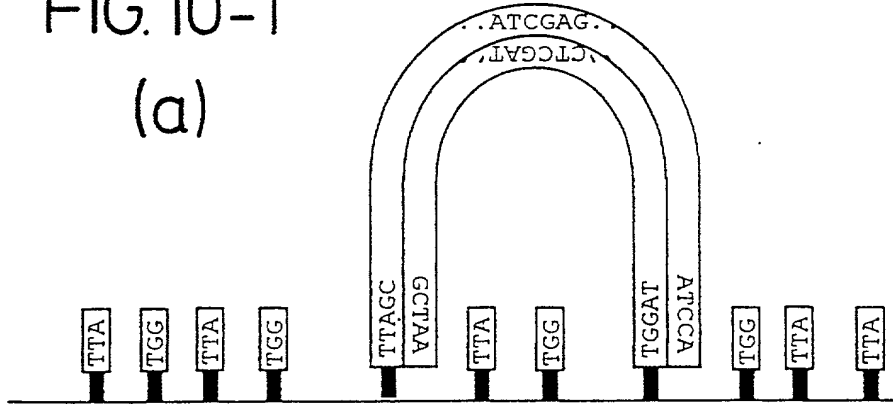

(b)

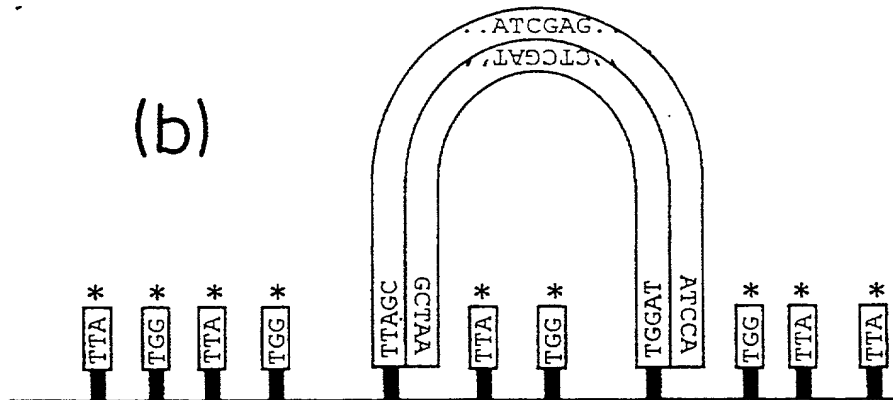

66666 22222

15 / 27

FIG. 10-2

(c)

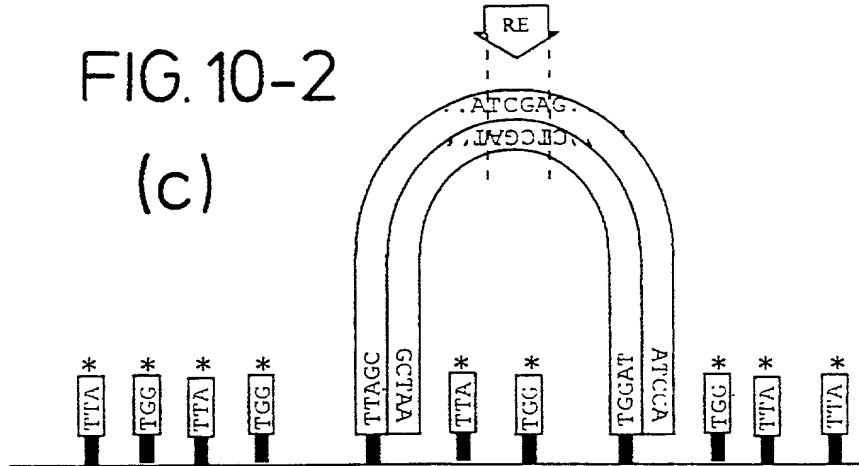

(d)

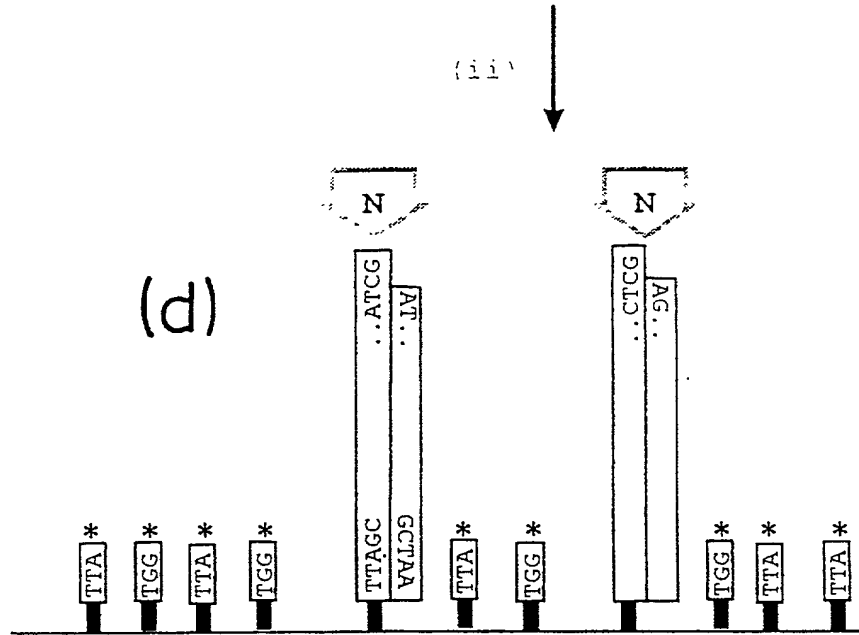

(e)

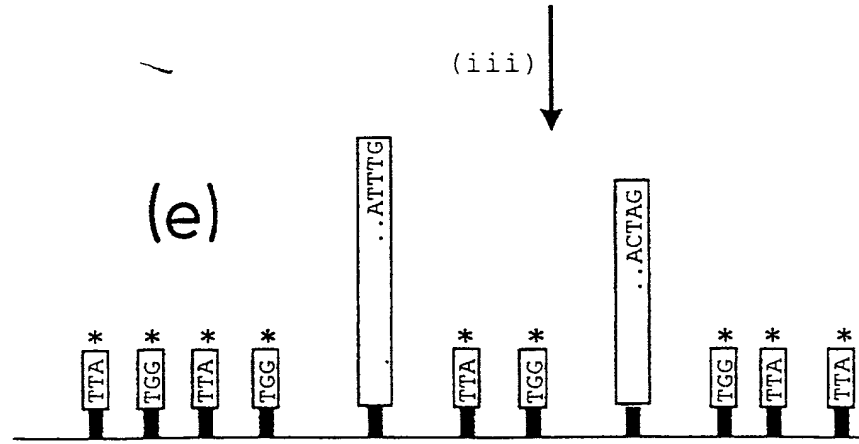

660666 7660660

16 / 27

FIG. 10-3

(f)

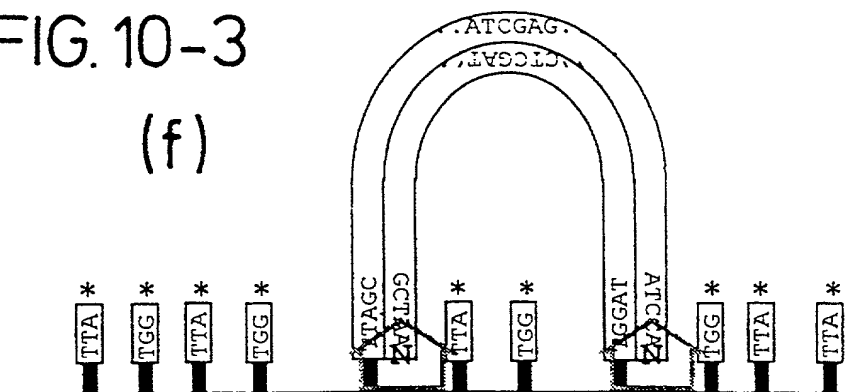

(Δ)



(g)

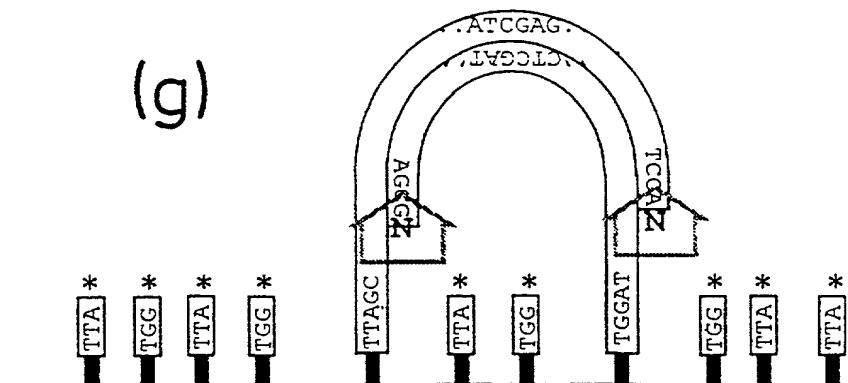

(∇)



(h)

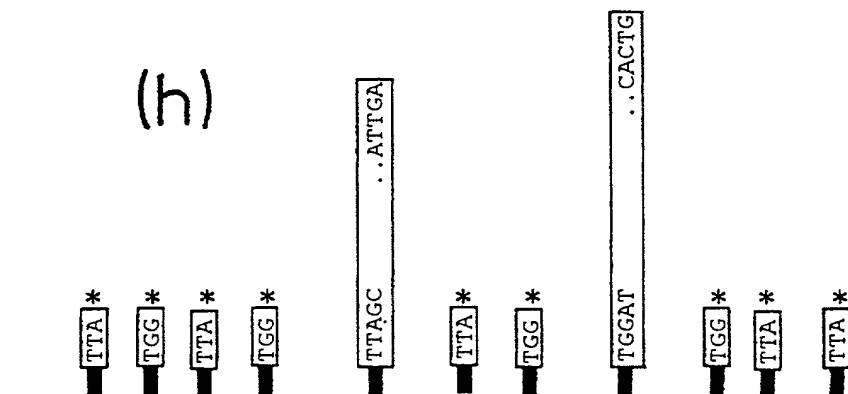

66653 422460

17 / 27

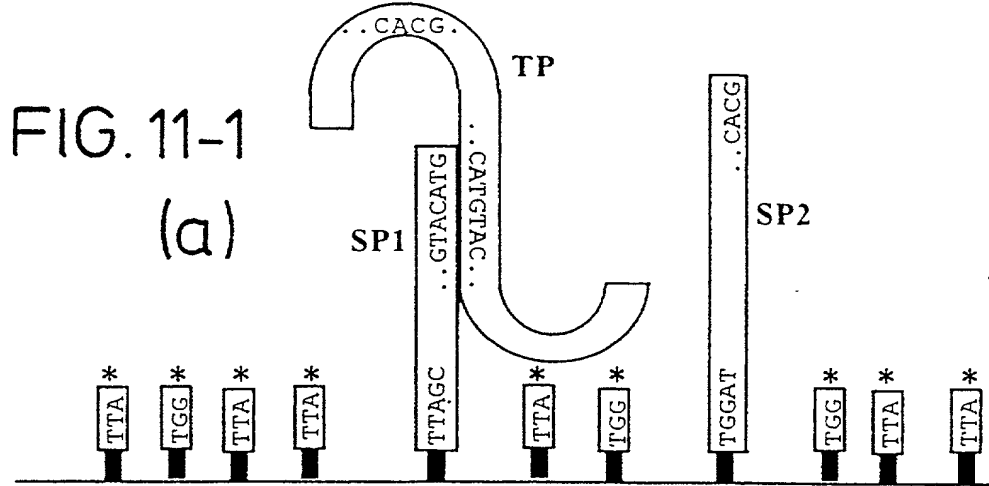

(i)

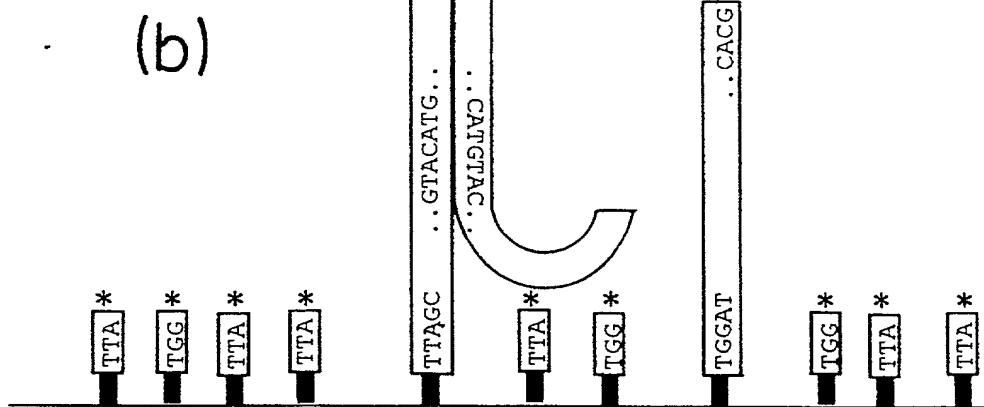

(ii)

56669 423660

18 / 27

FIG. 11-2

(c)

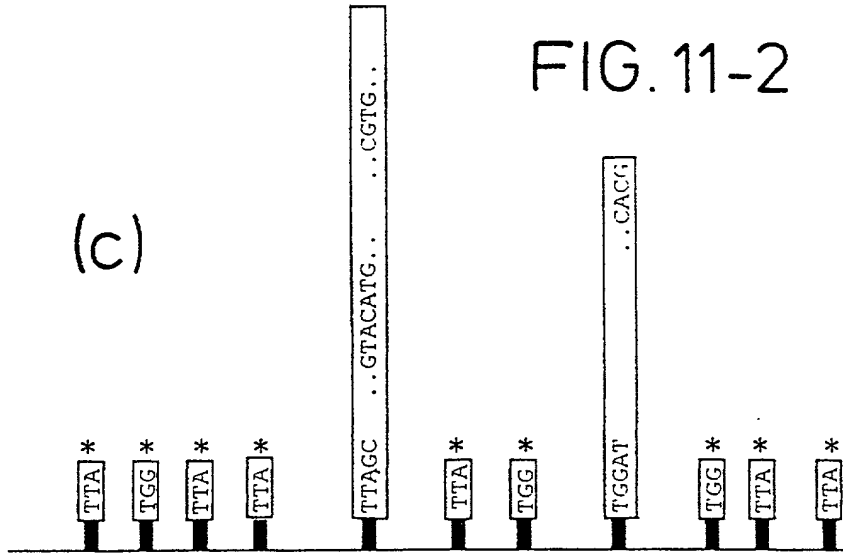

(iii)

(d)

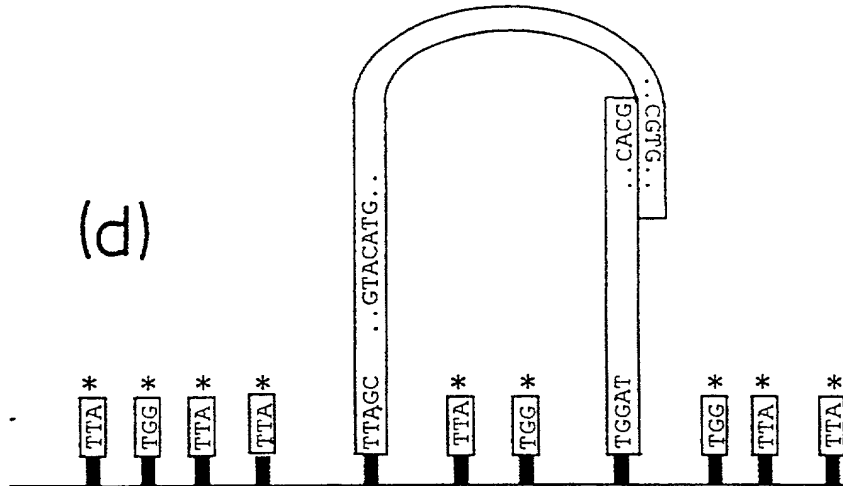

(iv)

(e)

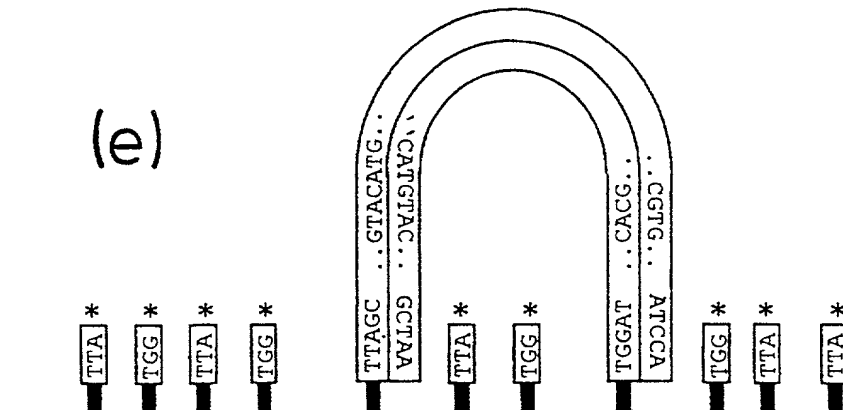

66660 220460

19 / 27

FIG. 12-1

(a)

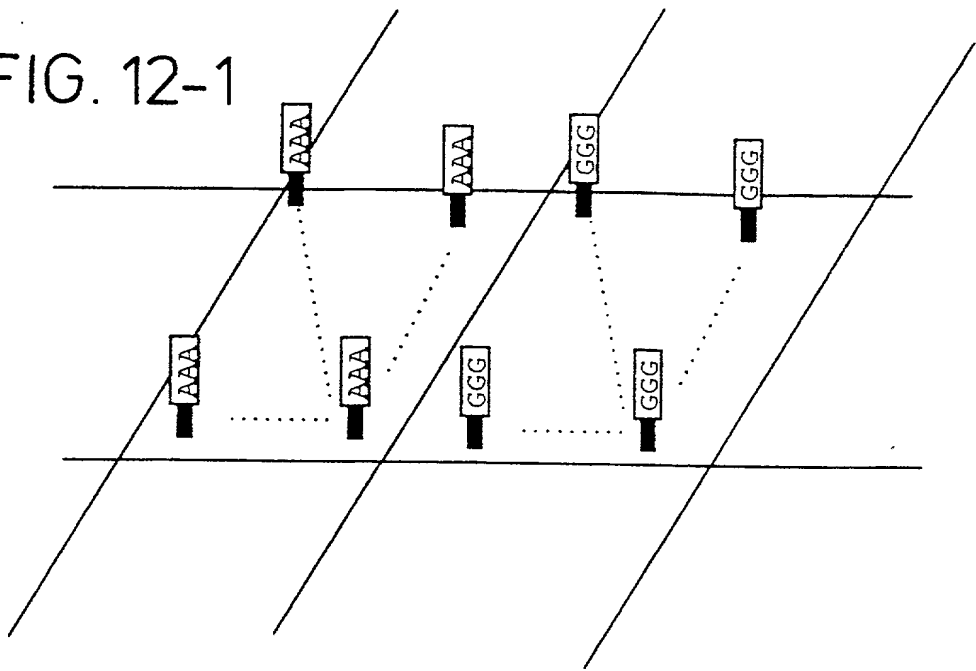

(i)

(b)

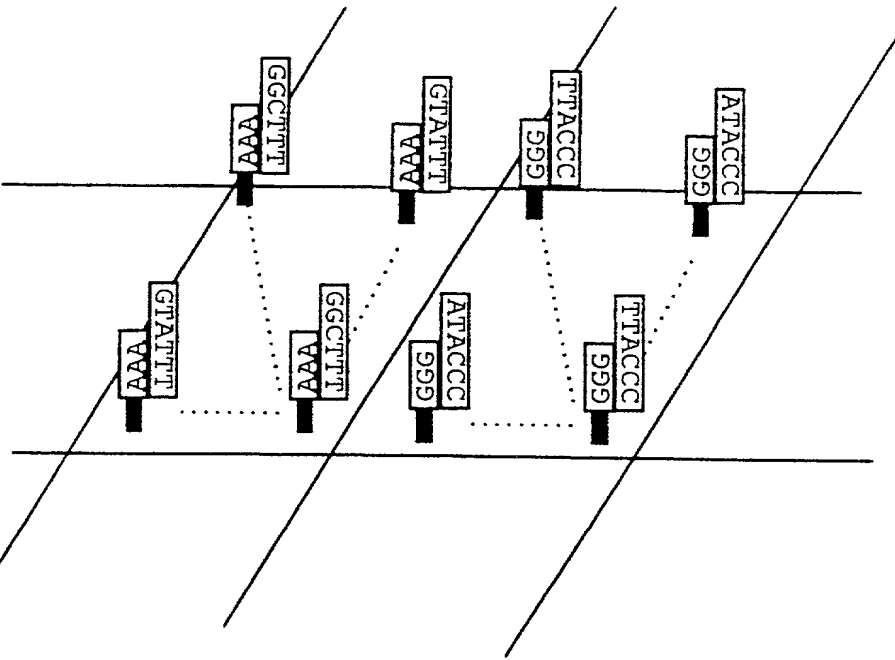

(ii)

20 / 27

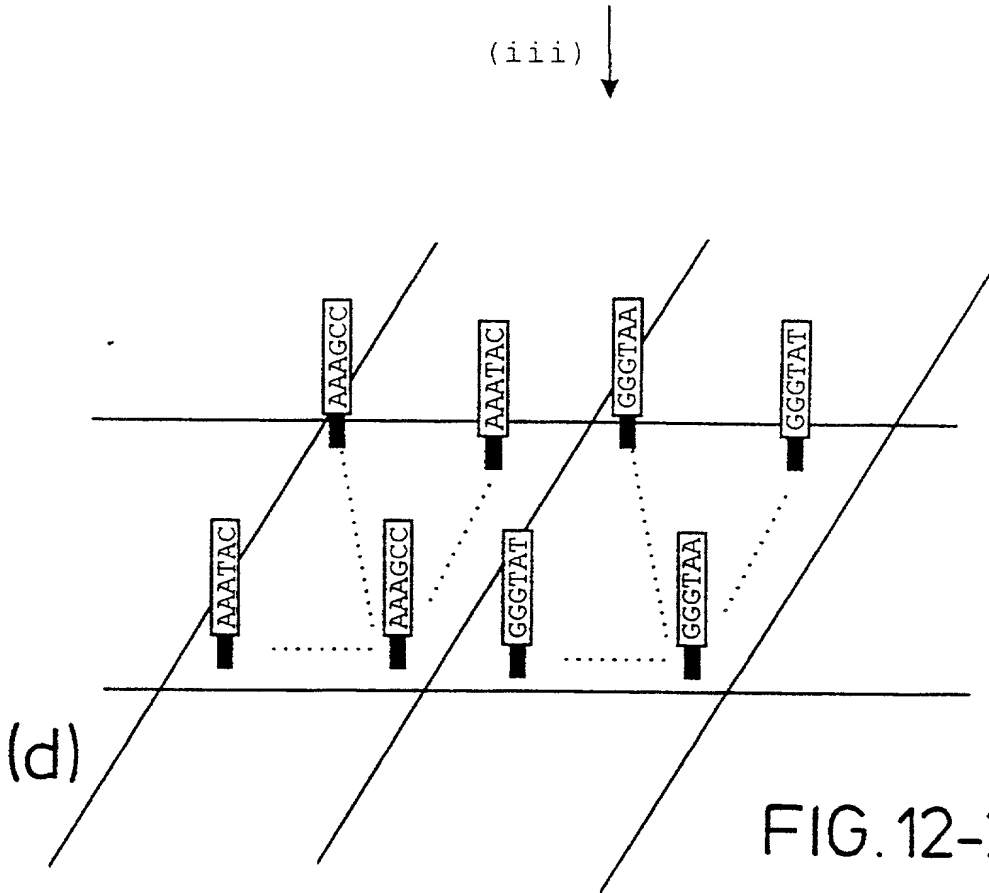
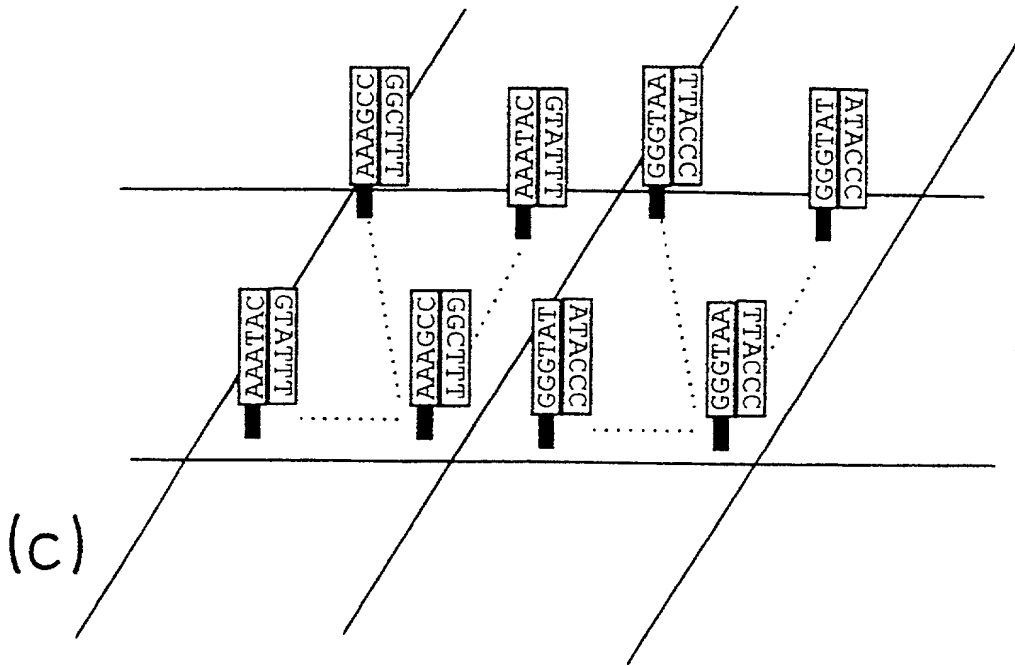

FIG.12-2

660660 4226460

21 / 27

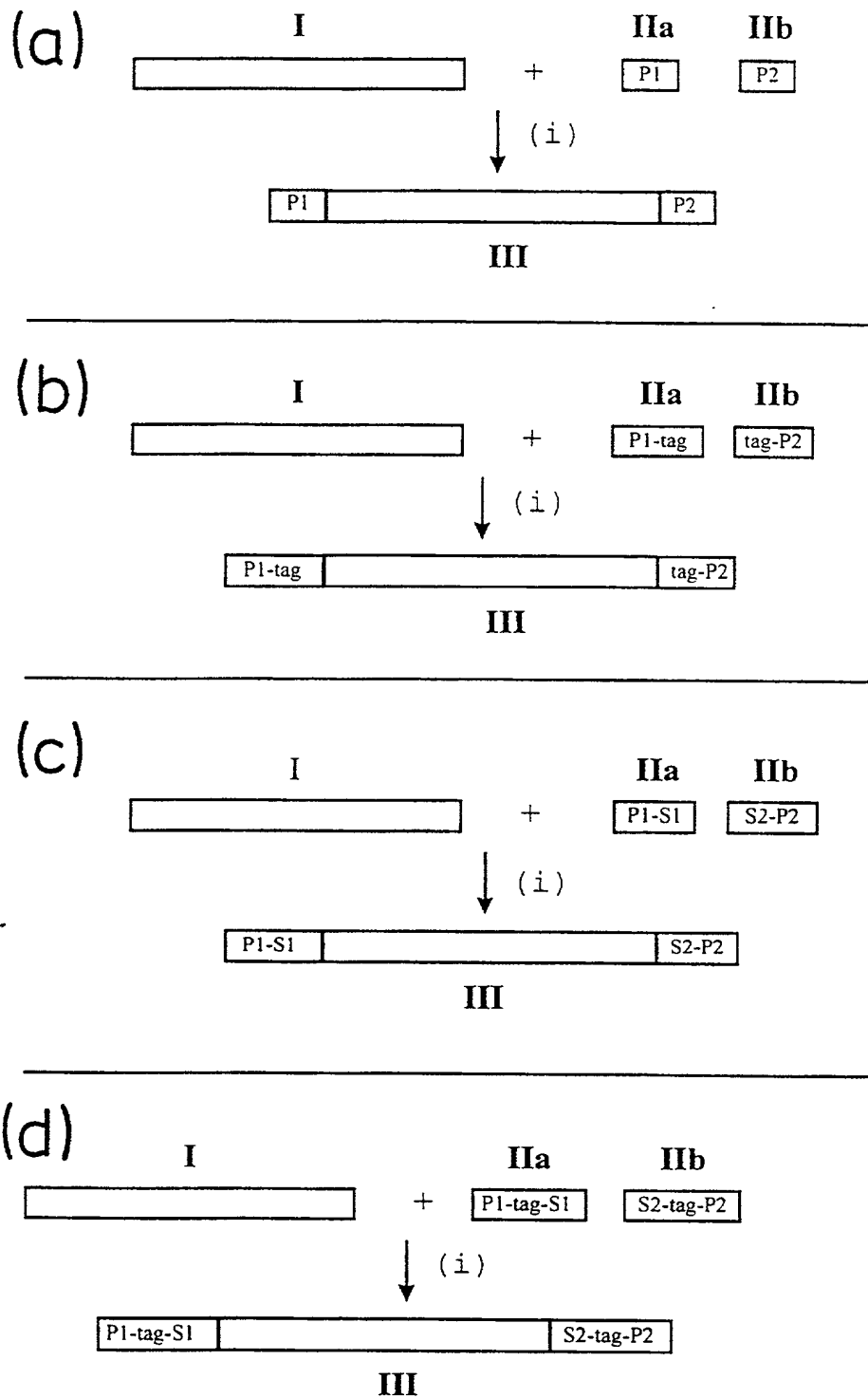

FIG. 13

22/27

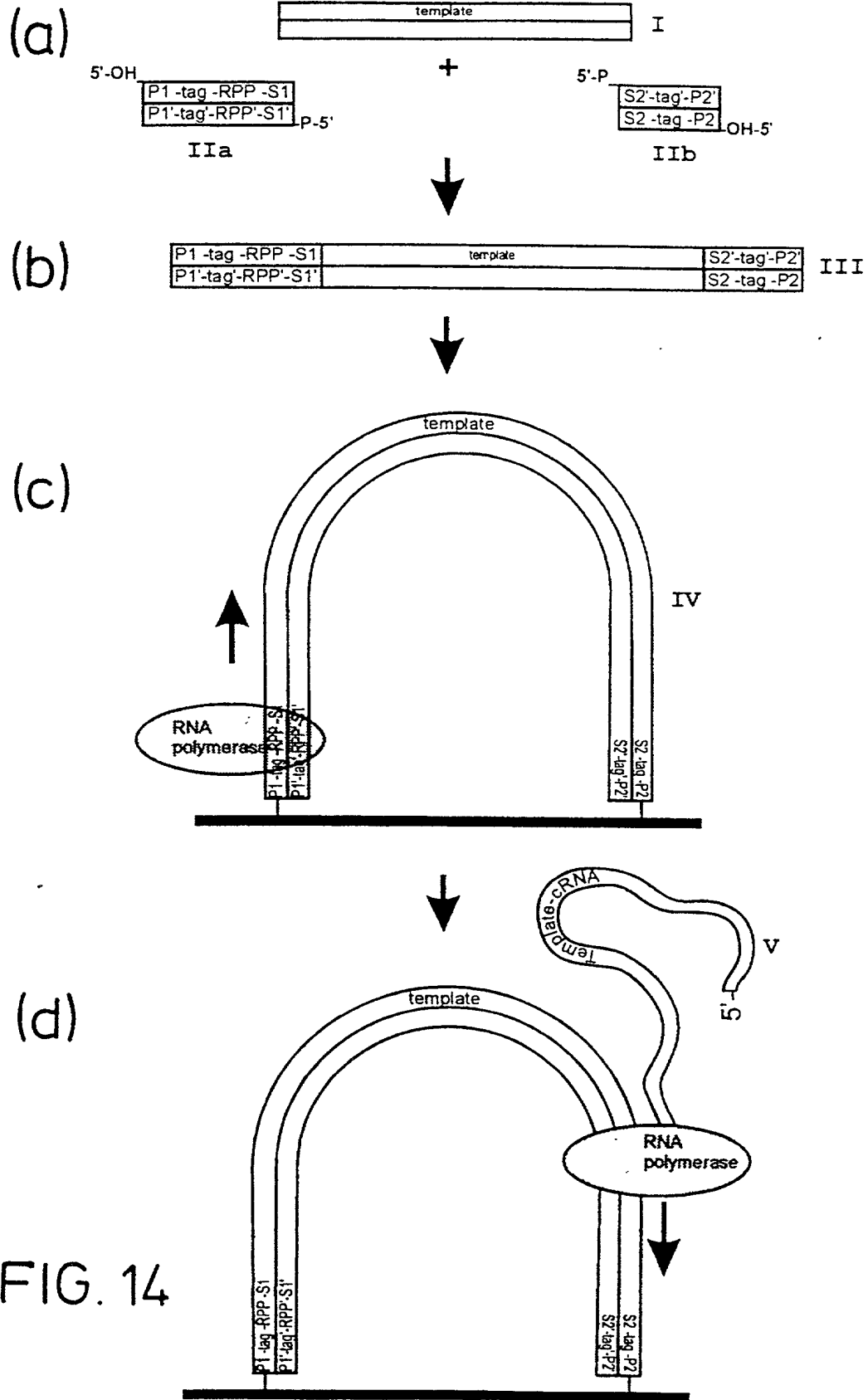

FIG. 14

23/27

FIG. 15

in situ Sequencing

(a)

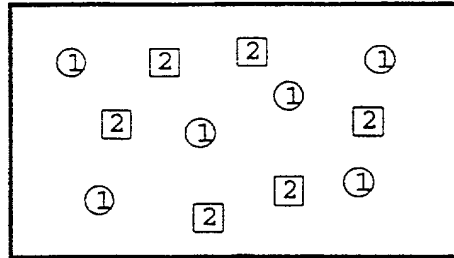

Two types of randomly arrayed DNA colonies

(b)

step 1
add dGTP

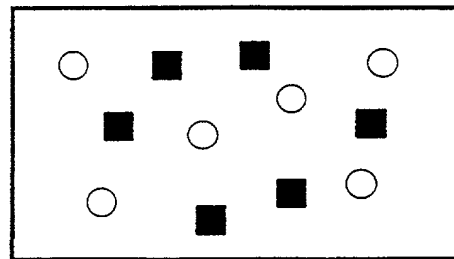

(c)

step 2
add dATP

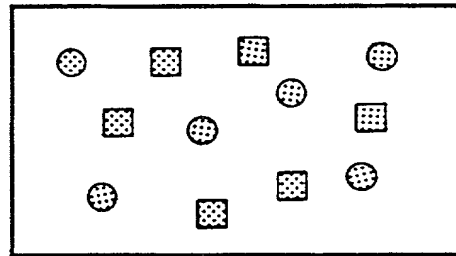

(d)

step 3
add dTTP

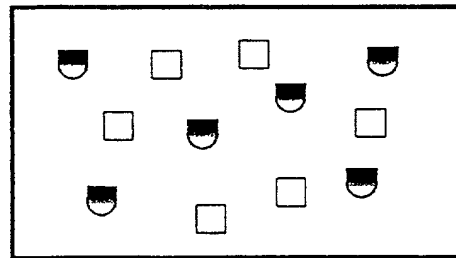

(e)

step 4
add dCTP

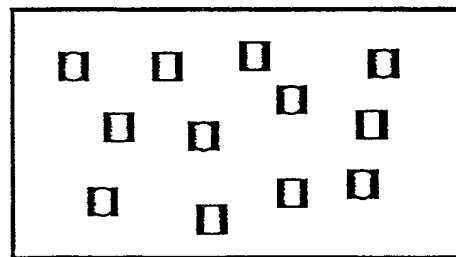

f)

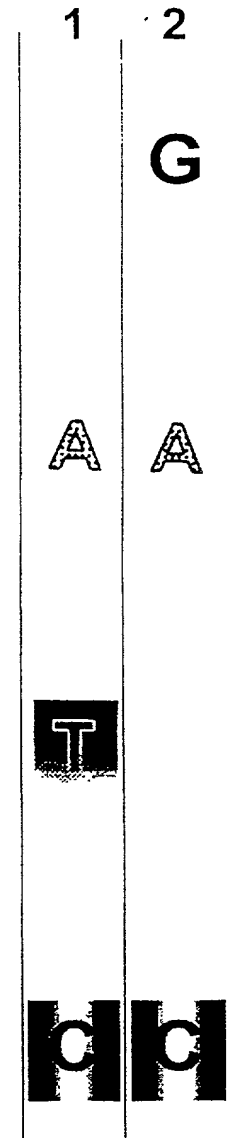

DNA sequence:
type 1: ATC
type 2: GAC

66060 44220460

24/27

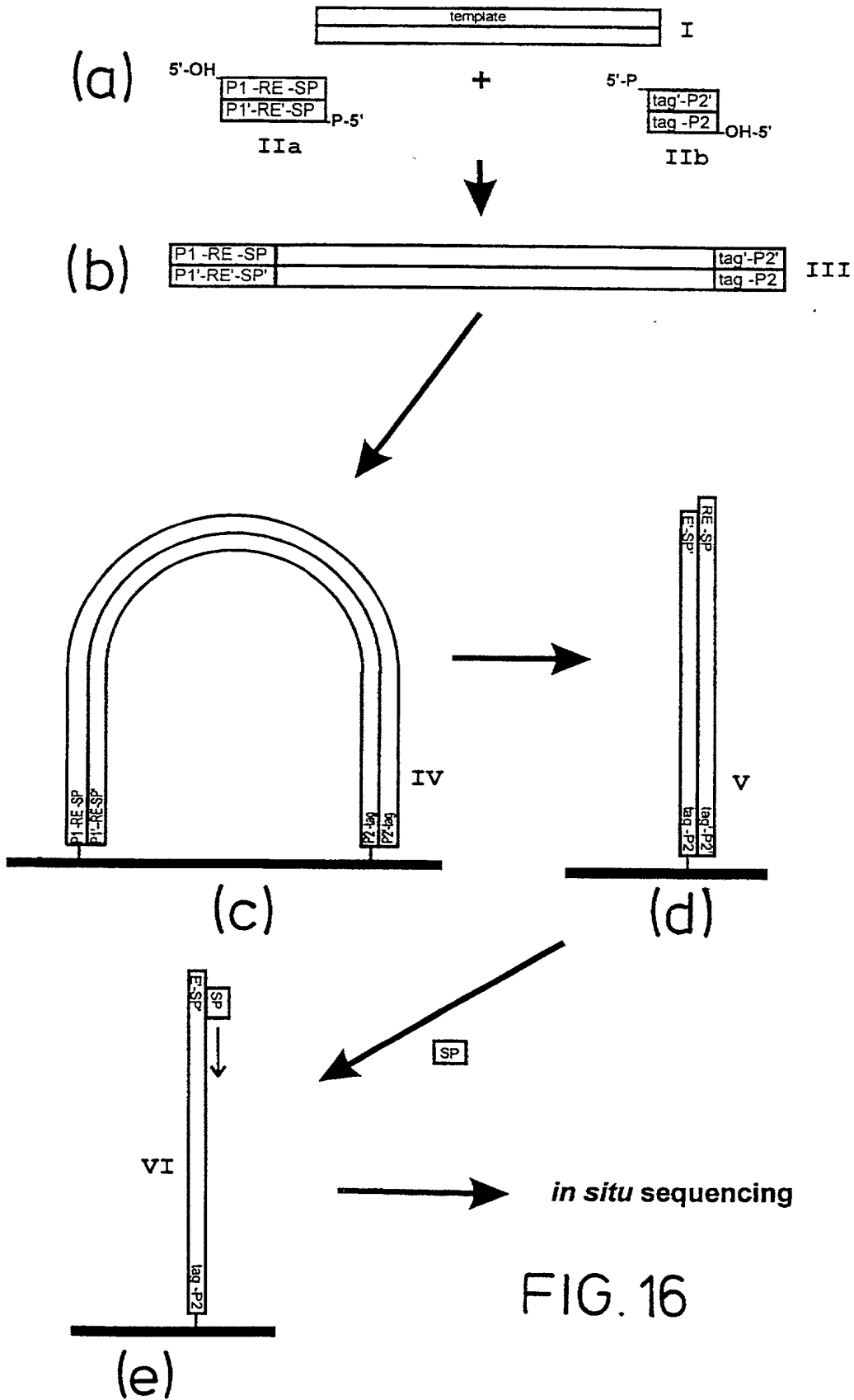

FIG. 16

25 / 27

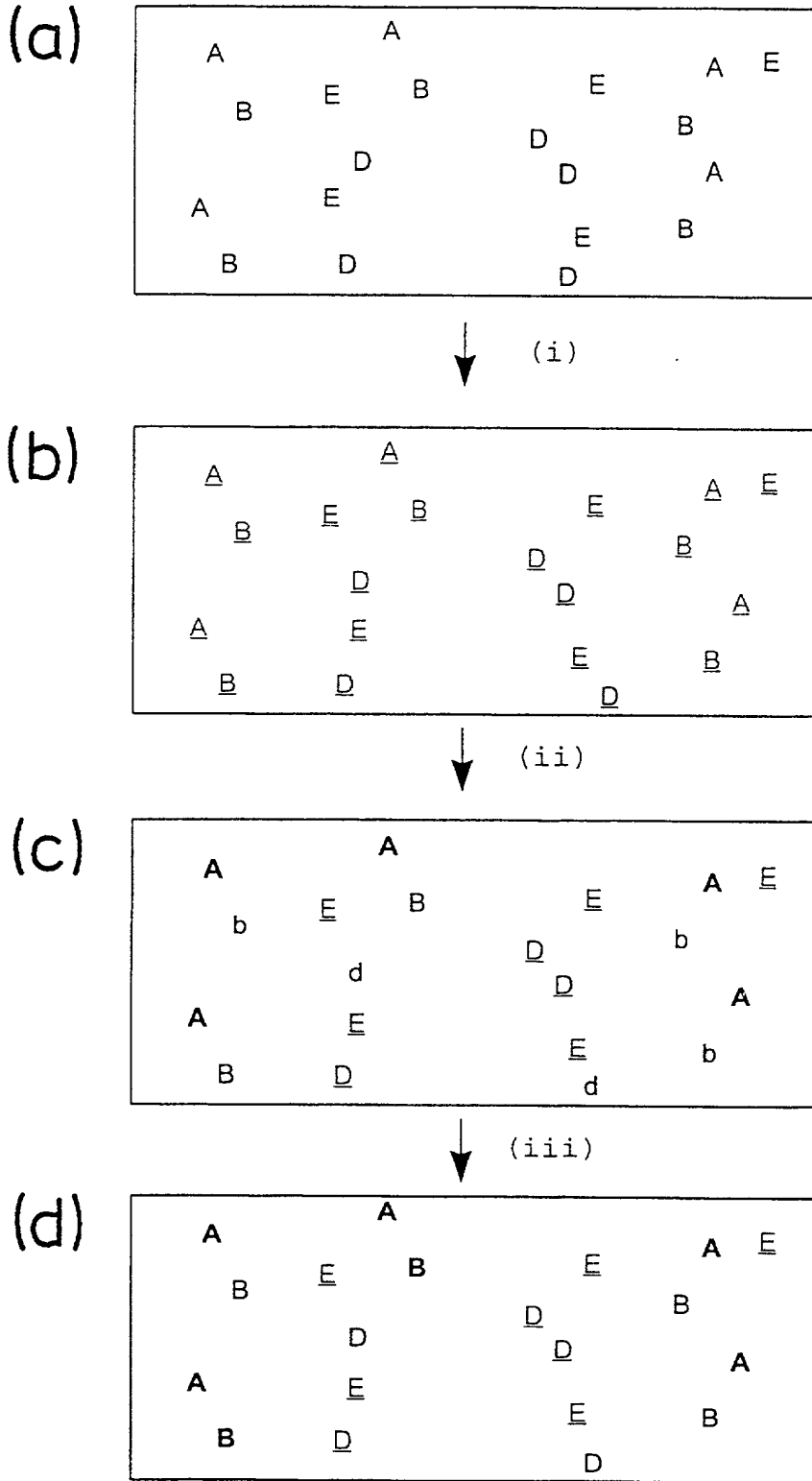
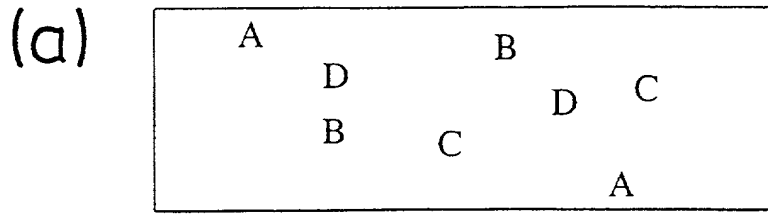

FIG. 17

66666666666666

26 / 27



↓ (i)

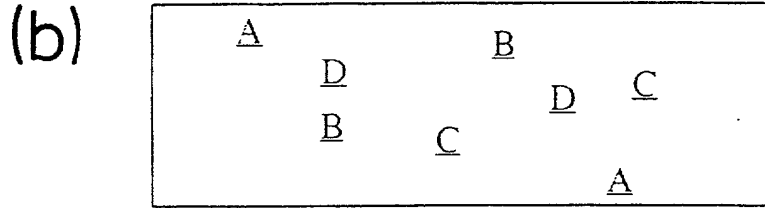

$mA + mB$ ↓ (ii)

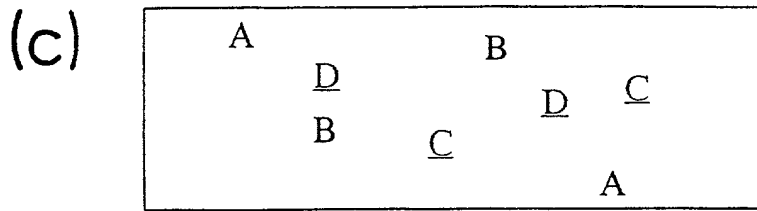

R.E. ↓ (iii)

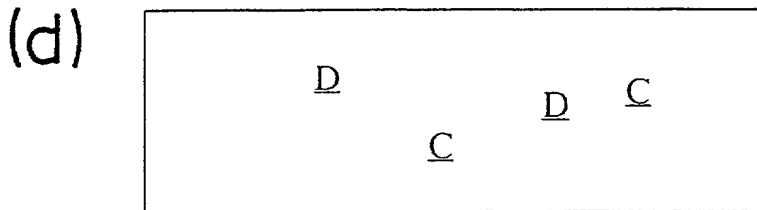

$mA +$ ↓ (iv)

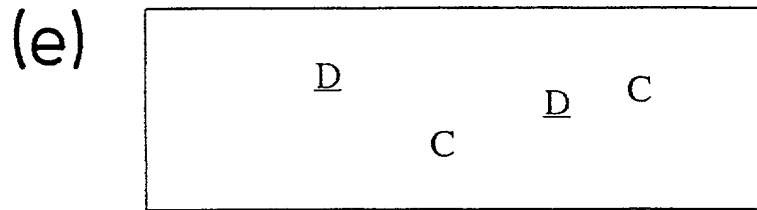

P1 + ↓ (v)



FIG. 18

6666046660

27 / 27

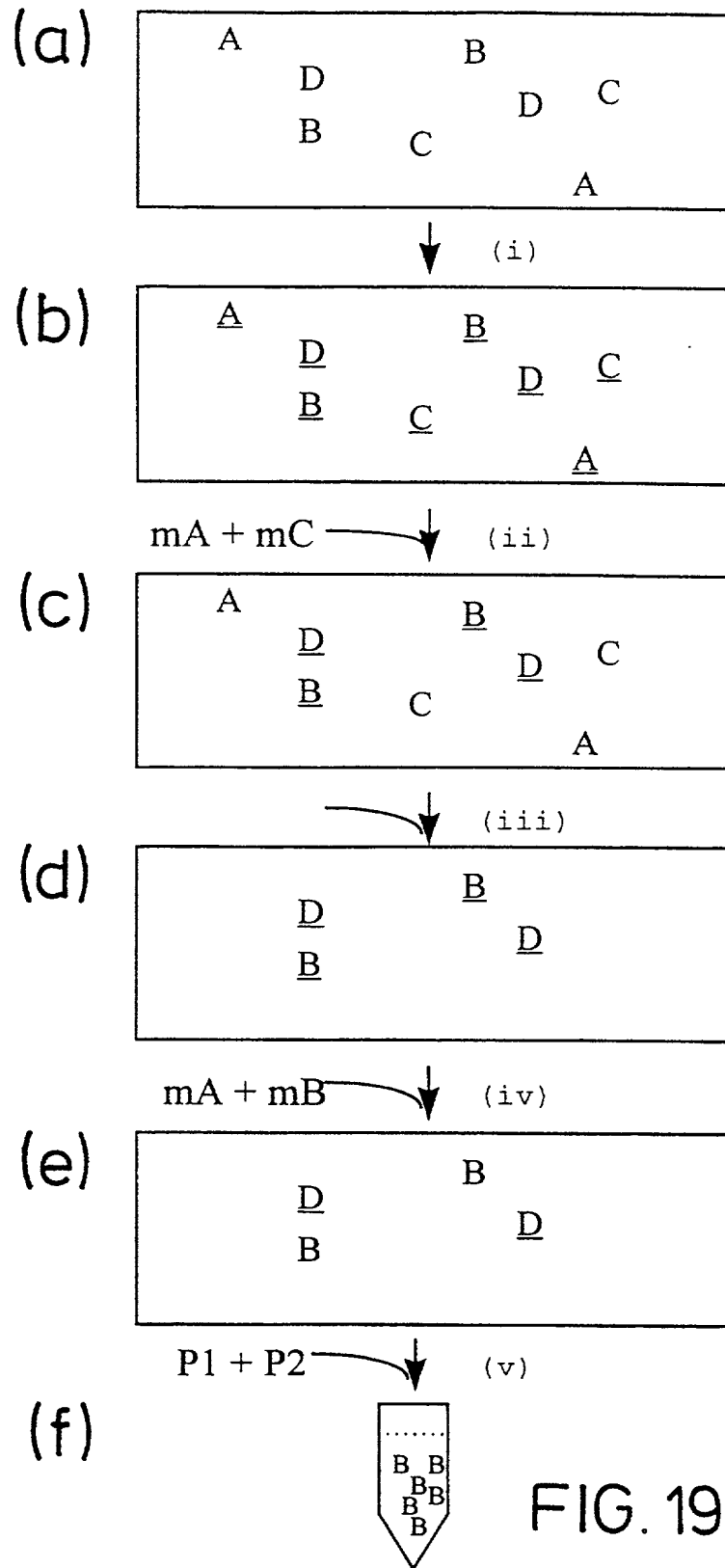

FIG. 19

66660 422277

DECLARATION AND POWER OF ATTORNEY

As a below named inventor, I declare that:

My residence, post office address and citizenship are as stated below next to my name; I believe I am the original, first and sole inventor (if only one name is listed below) or an original, first and joint inventor (if plural inventors are named below) of the subject matter which is claimed and for which a patent is sought on the invention entitled: **Method of Nucleic Acid Amplification** the specification of which _____ is attached hereto or X was filed on **September 30, 1999** as Application No. **09/402,277** and was amended on _____ (if applicable).

I have reviewed and understand the contents of the above identified specification, including the claims, as amended by any amendment referred to above. I acknowledge the duty to disclose information which is material to patentability as defined in Title 37, Code of Federal Regulations, Section 1.56. I claim foreign priority benefits under Title 35, United States Code, Section 119 of any foreign application(s) for patent or inventor's certificate listed below and have also identified below any foreign application for patent or inventor's certificate having a filing date before that of the application on which priority is claimed.

Prior Foreign Application(s)

Country	Application No.	Date of Filing	Priority Claimed Under 35 USC 119
GB	9706528.8	04/01/97	yes
GB	9706529.6	04/01/97	yes
GB	9713236.9	06/23/97	yes
GB	9713238.5	06/23/97	yes
PCT	PCT/GB98/00961	04/01/98	yes

I claim the benefit under Title 35, United States Code, Section 120 of any United States application(s) listed below and, insofar as the subject matter of each of the claims of this application is not disclosed in the prior United States application in the manner provided by the first paragraph of Title 35, United States Code, Section 112, I acknowledge the duty to disclose material information as defined in Title 37, Code of Federal Regulations, Section 1.56 which occurred between the filing date of the prior application and the national or PCT international filing date of this application:

Application No.	Date of Filing	Status

POWER OF ATTORNEY: As a named inventor, I hereby appoint the following attorney(s) and/or agent(s) to prosecute this application and transact all business in the Patent and Trademark Office connected therewith.

- 7
- Randolph T. Apple, Reg. No. 36,429
 - Krishna G. Banerjee, Reg. No. 43,317
 - Karen B. Dow, Reg. No. 29,684
 - Jeffrey A. McKinney, Reg. No. 43,795
 - Andrew T. Serafini, Reg. No. 41,303
 - Joe Liebeschuetz, Reg. No. 37,505
 - William M. Smith, Reg. No. 30,223

Send Correspondence to: <u>William M. Smith</u> TOWNSEND and TOWNSEND and CREW LLP Two Embarcadero Center, 8th Floor San Francisco, California 94111-3834	Direct Telephone Calls to: (Name, Reg. No., Telephone No.) Name: William M. Smith Reg. No.: 30,223 Telephone: 650-326-2400
-------------------------------------------------------------------------------------------------------------------------------------------------------------------------------------------------------	----------------------------------------------------------------------------------------------------------------------------------------



1-0

2W

3W

Full Name of Inventor 1:	Last Name: KAWASHIMA	First Name: ERIC	Middle Name or Initial: H.	
Residence & Citizenship:	City: GENEVA CHX	State/Foreign Country: SWITZERLAND	Country of Citizenship: U.S.	
Post Office Address:	Post Office Address: SERONO PHARMACEUTICAL RESEARCH INSTITUTE SA 14 CHEMIN DES AULX 1228 PLAN LES OUATES	City: GENEVA	State/Country: SWITZERLAND	Postal Code:
Full Name of Inventor 2:	Last Name: FARINELLI	First Name: LAURENT	Middle Name or Initial:	
Residence & Citizenship:	City: VEVEY CHX	State/Foreign Country: SWITZERLAND	Country of Citizenship: SWITZERLAND	
Post Office Address:	Post Office Address: NESTLÉ	City: VEVEY	State/Country: SWITZERLAND	Postal Code: 1800
Full Name of Inventor 3:	Last Name: MAYER	First Name: PASCAL	Middle Name or Initial:	
Residence & Citizenship:	City: GENVA CHX	State/Foreign Country: SWITZERLAND	Country of Citizenship: FRENCH	
Post Office Address:	Post Office Address: SERONO PHARMACEUTICAL RESEARCH INSTITUTE SA 14 CHEMIN DES AULX 1228 PLAN LES OUATES	City: GENEVA	State/Country: FRANCE	Postal Code:

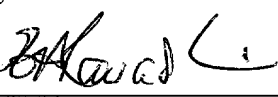
I further declare that all statements made herein of my own knowledge are true and that all statements made on information and belief are believed to be true; and further that these statements were made with the knowledge that willful false statements and the like so made are punishable by fine or imprisonment, or both, under Section 1001 of Title 18 of the United States Code, and that such willful false statements may jeopardize the validity of the application or any patent issuing thereon.

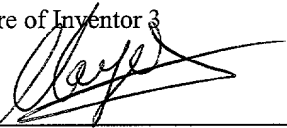
Signature of Inventor 1  <u>ERIC H. KAWASHIMA</u> Date: 20/1/2000	Signature of Inventor 2  <u>LAURENT FARINELLI</u> Date: 24/1/2000	Signature of Inventor 3  <u>PASCAL MAYER</u> Date: 20/1/2000
---------------------------------------------------------------------------------------------------------------------------------------------------------------	---------------------------------------------------------------------------------------------------------------------------------------------------------------	------------------------------------------------------------------------------------------------------------------------------------------------------------